Power Quality Instrument User Manual

Applied to:

Sfere820A

Notices for Use

Please read this manual carefully before using this device and be sure to observe the following notes while using it:

NOTE:

- This device must be operated and maintained by a professional who has read this manual.
- Before performing any internal or external operations on the device, disconnect all input signals and power supplies and make sure that the secondary terminals of the voltage transformer are not short-circuited and the secondary terminals of the current transformer are not open-circuited.
- Be sure to use an appropriate voltage measuring device to confirm that there is no voltage present in any of the device's components.
- The electric parameters supplied to the device must be within the rated range.
- Please do not touch the terminals of the device while it is working.
- To use the communication function of the device, please connect it to a secure communication network.

The following circumstances may result in the device being damaged or operating improperly:

- The operating environment is out of range.
- The voltage of the auxiliary power supply is out of range.
- The frequency of the power distribution system is out of range.
- The signal input exceeds the maximum rating.
- The polarity of the current or voltage input is incorrect.
- The connection is not as required.

Without our legal written consent, no contents of this manual may be duplicated or disseminated. We are not liable for any errors or omissions in this manual that result in or bring about negative outcomes. The contents of this manual are subject to change without further notice. If you require a copy of this manual, please contact our technical service department or scan the QR code on the device label.

Contents

1. Introduction	5
1.1 Overview	5
1.2 Model	5
2. Technical Specification	7
3. Installation	8
3.1 Dimensions	8
3.2 Installation	9
3.3 Wirings	9
3.3.1 Typical Wiring Diagram	9
3.3.2 Voltage/Current Input Connection	10
3.3.3 Module Wiring	10
4. Operation	11
4.1 Panel	11
4.2 Display	12
4.2.1 Display Menu	12
4.2.2 Display Features	14
4.3 Setup	27
4.3.1 Setup Menu	27
4.3.2 Basic Parameter Setup	29
4.3.3 Signal Input Setup	31
4.3.4 Communication Setup	31
4.3.5 Digital Input Setup	31
4.3.6 Relay Output Setup	32
4.3.7 Power quality threshold setup	32
4.3.8 Power quality event setup	32
4.3.9 Module setup	33
4.3.10 Reset setup	33
4.3.11 Demand setup	34
4.3.12 Time setup	34
4.3.13 EN50160 Setup	34
5. Functions	35
5.1 Real-time measurements	35

5.2 Energy metering	35
5.3 Demand	36
5.3.1 Sliding Block Demand	37
5.3.2 Fixed Block Demand	38
5.4 Max/Min Values	38
5.5 Power Quality	38
5.6 Alarm	43
5.7 Event Log	45
5.8 Data Freezing	47
5.9 Address Mapping	47
5.10 Digital Input	48
5.11 Relay Output	48
5.12 Expand Module	48

1. Introduction

1.1 Overview

Sfere820A is characterized by precise power parameter measurement, energy metering, and power quality monitoring capabilities, and meets IEC 61000-4-30 A for power quality. With a rich package of I/O modules for on-site equipment state monitoring and control, it can be easily integrated with various intelligent power monitoring systems and energy management systems to share a wealth of monitoring data and power quality data.

1.2 Model

Functions		Sfere820A
Display Mode	TFT	5"
Real-time Measurement	3 phase voltage	•
	3 phase current	•
	Neutral current	•
	Active power	•
	Reactive power	•
	Apparent power	•
	Power factor	•
	Frequency	•
	Demand	•
	Max/Min values	•
Phase angle	•	
Energy Metering	Bi-directional active energy	•
	Bi-directional reactive energy	•
	Four-quadrant reactive electric energy	•
	Apparent energy	•
	Bi-directional tariff energy	•
Power Quality	Voltage deviation	•
	Frequency deviation	•
	Unbalance	•
	THD	•
	Harmonic ratio(2 nd -51 st)	•

	Inter-harmonic ratio	●
	Voltage flicker	●
	Rapid voltage change	●
	Voltage swell	●
	Voltage dip	●
	Voltage interruption	●
	Crest factor	●
	k-factor of current	●
	Transient capture	80μs
	ITIC/SEMI F47 curve	●
Alarms	Voltage	●
	Current	●
	Active power	●
	Reactive power	●
	Apparent power	●
	Power factor	●
	Frequency	●
Data Records	SOE log	1,024 events
	PQ event log	1,024 events
	Waveform record	1,024 events
	Data freeze	●
	EN50160 report	60 events
Input/Output	Digital input	4
	Relay output	4
Communication	RS485 interface	●
Time synchronization	IRIG-B	●
	Modbus- RTU	●
Optional Modules	FM2: 4 digital inputs	○
	FM3: 2 relay outputs	○
	FM11: RS485 port, Modbus-RTU protocol	
	FM24: Ethernet port, Modbus-TCP protocol, Webserver	○

[Note 1]: “-” - not available, “●”- available, “○” - optional.

2. Technical Specification

Accuracy	
Voltage,Current	0.1%
Active Power,Reactive Power	0.2%
Power Factor	0.2%
Frequency	±0.01Hz
Active Energy	Cl. 0.2S
Reactive Energy	Cl. 2
Power Quality Parameters	IEC 61000-4-30 Cl. A
Environmental Characteristics	
Working Temperature	-25°C...+70°C
Storage Temperature	-25°C...+70°C
Relative Humidity	5%...95%RH, without condensation
Working Altitude	≤ 2000m (CAT III)
Pollution Degree	2
Mechanical Characteristics	
Dimension	144mm×144mm×80mm
Protection Degree	Face frame: IP54; rear housing: IP20
Safety Characteristics	
Measurement Category	300V (CAT III)
Safety	IEC 61010-1, double insulation
Auxiliary Power Supply	
Voltage	AC/DC 80V...270V
Frequency	50/60Hz ± 5Hz
Power Consumption	≤ 10VA
Voltage Input	
Rated Value	3×230/400 VAC
Starting Value	10 V
Overload	Continuous: 1.2Vn; instantaneous: 2Vn/1min
Frequency	45Hz...65Hz
Current Input	
Rated Value	3×.../1A or .../5A
Starting Value	10mA
Overload	Continuous: 2In; instantaneous: 20In/0.5s
Switching Input	
Number	4
Type	Dry contact, built-in DC 24V
Relay Output	
Number	4
Contact Capacity	AC 250V/5A or DC30V/5A
Pulses of Electric Energy	
Number	1
Type	Photocoupler isolation
Communication Port	
Number	1
Port	RS485
Baud rate	2.4kbps...115.2kbps
Protocol	Modbus-RTU
Real-time Clock	
Clock Drifting	≤ 0.5s/day

Terminals	
Torque	0.5N·m
Standards	
GB/T 39853 IEC 62586	Power Quality Measurement in Power Supply System
GB/T 18216.12 IEC 61557-12	Power metering and monitoring devices (PMD)
GB/T 17626.2 IEC 61000-4-2	Immunity to electrostatic discharge,Level 4
GB/T 17626.3 IEC 61000-4-3	Immunity to radio-frequency field,Level 3
GB/T 17626.4 IEC 61000-4-4	Immunity to electrical fast transients/bursts,Level 4
GB/T 17626.5 IEC 61000-4-5	Surge Immunity,Level 4
GB/T 17626.8 IEC 61000-4-8	Immunity to power frequency magnetic fields,Level 4

3. Installation

3.1 Dimensions

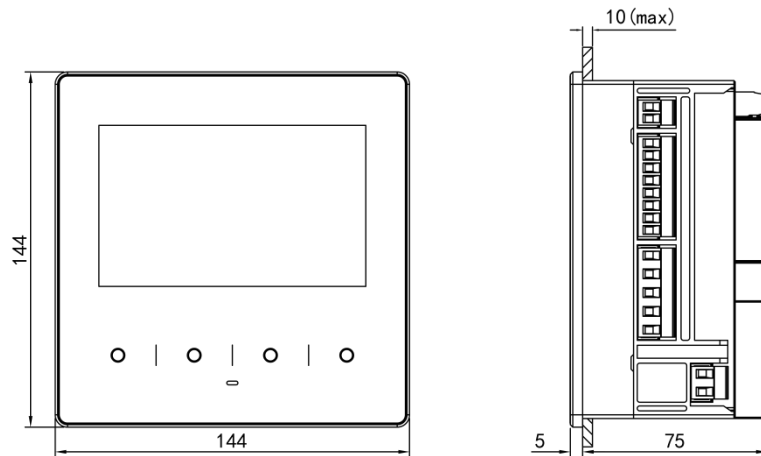

Figure 3.1.1 Sfere820A (Unit: mm)

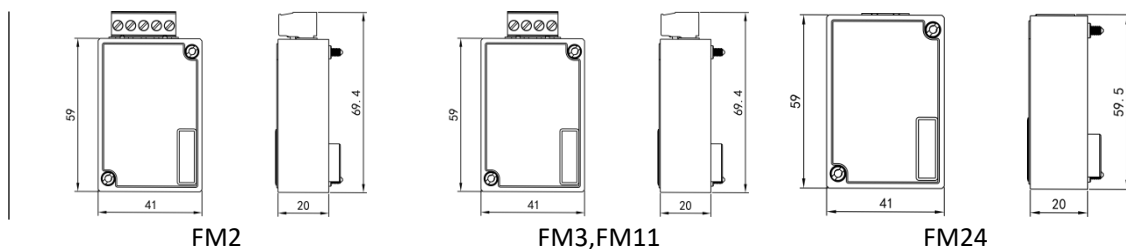

Figure 3.1.2 Extension Module (Unit: mm)

3.2 Installation

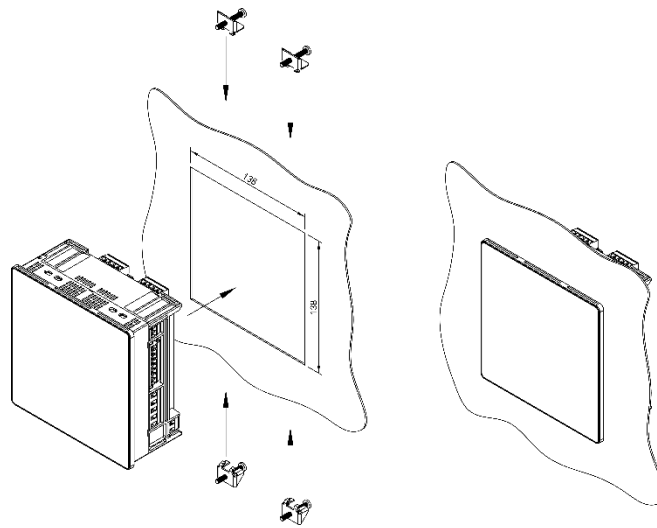

Figure 3.2.1 Installation Diagram

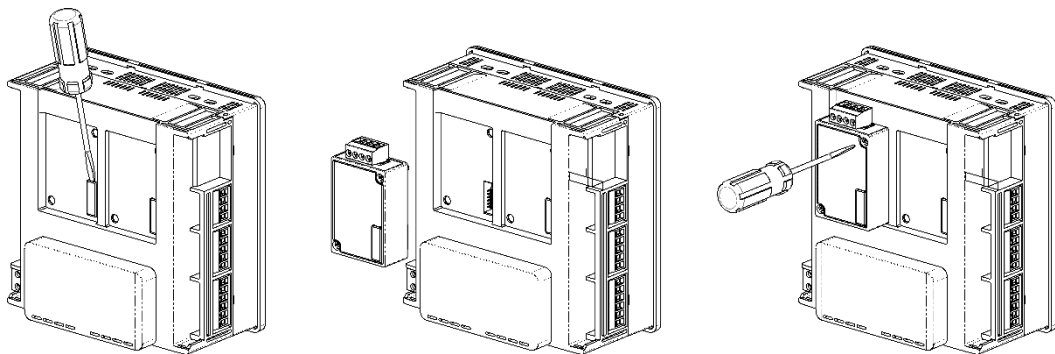

Figure 3.2.2 Module installation Diagram

3.3 Wirings

3.3.1 Typical Wiring Diagram

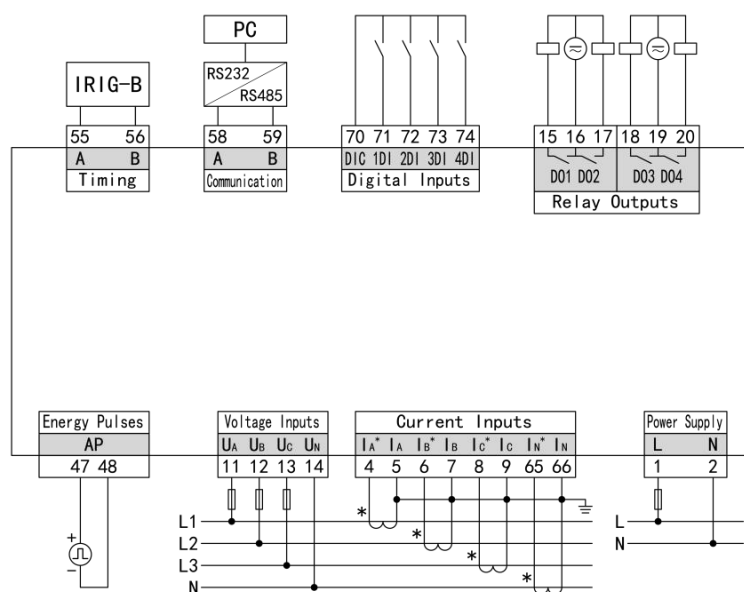

Figure 3.3.1.1 Typical wiring diagram

3.3.2 Voltage/Current Input Connection

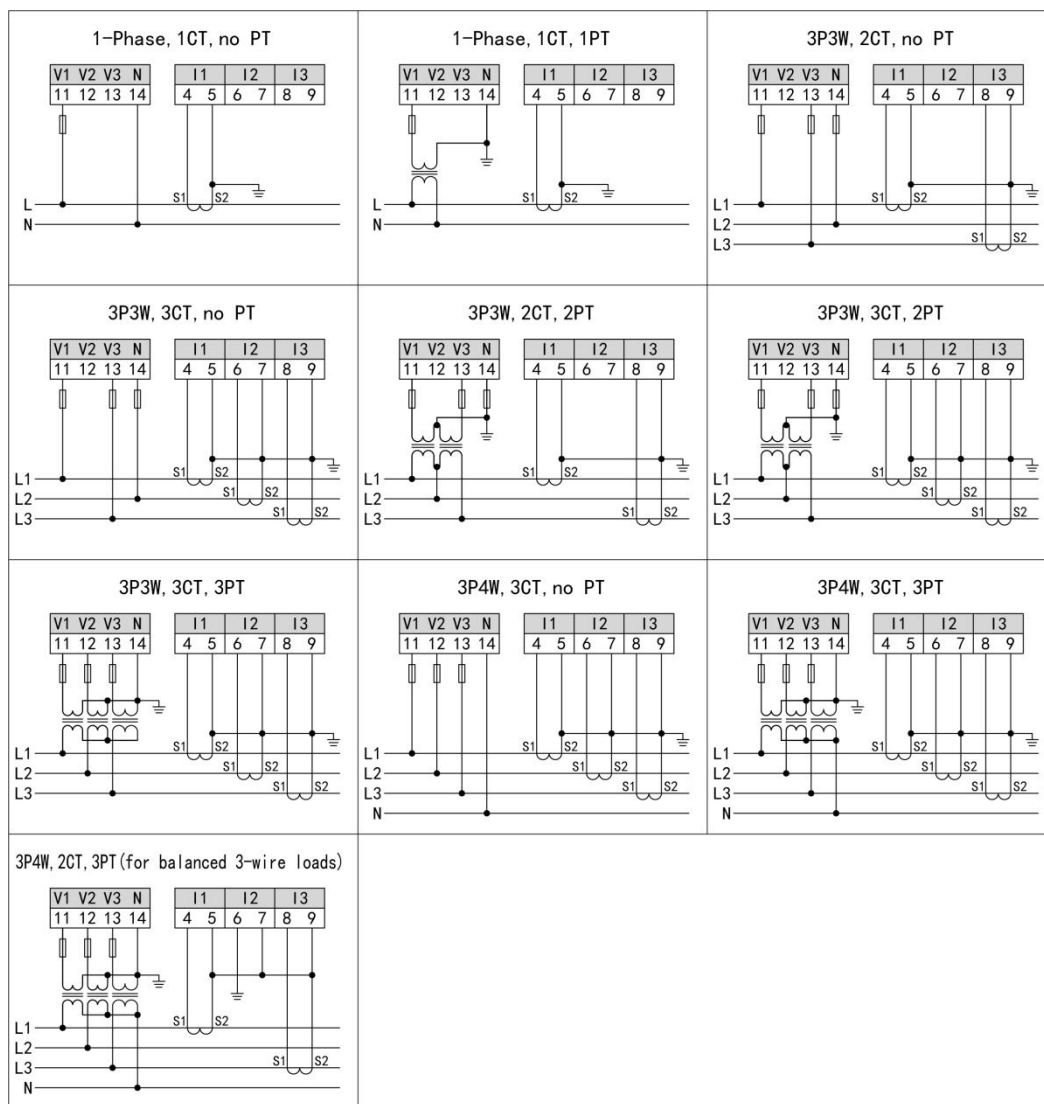
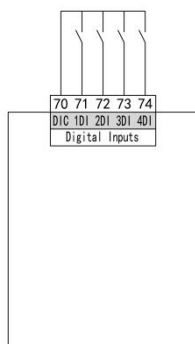
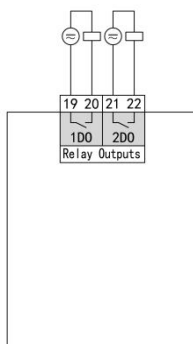

Figure 3.3.2.1 Voltage/Current Input Connection Diagram

3.3.3 Module Wiring



Module-FM2



Module-FM3

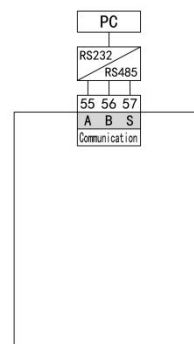

Module-FM11 模块

4. Operation

4.1 Panel

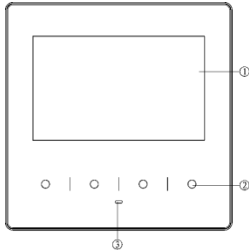

① Display window

Content Prompt: The currently displayed content will be prompted in the center of each interface;

Page Number: Each interface has a unique number, which is displayed in the upper right corner of the interface;

Data Window: It displays various data contents;

② Button

There are four prompt areas for button function icons at the bottom of each interface, indicating the present function of each physical button.

Users can set the device parameters with those buttons.

③ Indicator led

Button functions

Icons	Description
	Increase the selected data bits.
	Move down the options/page down/change parameters.
	Move in a circular way to the left to change or display data.
	Move in a circular way to the right to change or display data.
	Return directly to the "Main Menu" page, return to the previous menu or discard modifications.
	Enter the selected option.
	Confirm.
	Zoom in or out to display the image.
	Edit the options.
	Turn to next page.
	Invalidate the present button.

Modification methods for values:

Press "

 to move and modify the data bit, and then press " to cyclically increase the present data bit.

Entering and exiting of programming state:

Entering of programming state: On the main interface, press "

 and " to change the selected item into "System Setup", and then press " to enter the interface of programming setup. Generally, users can enter by selecting "User Setup". After entering the correct programming protection password, they will enter the programming Setup and start setting parameters (the

default programming password is 0001, and users can modify it as necessary).

Exiting of programming state: When you have already returned to the first-tier menu of programming interface, press the button “  ”. Now, the device will prompt whether to save the modifications. Select “Yes” to save the modifications and return to the main menu, or select “No” to abandon saving the modifications and return to the main menu.

4.2 Display

4.2.1 Display Menu

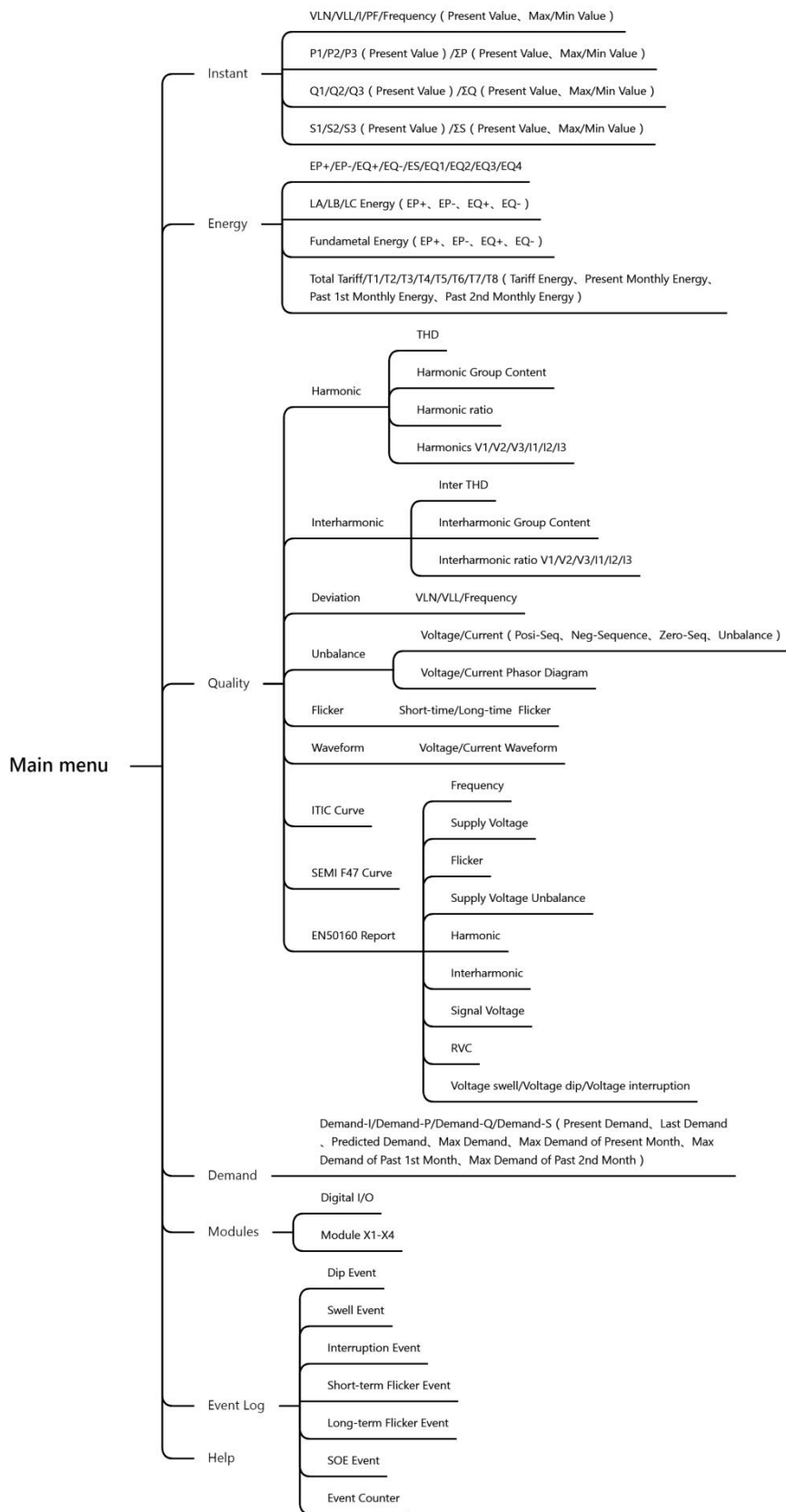

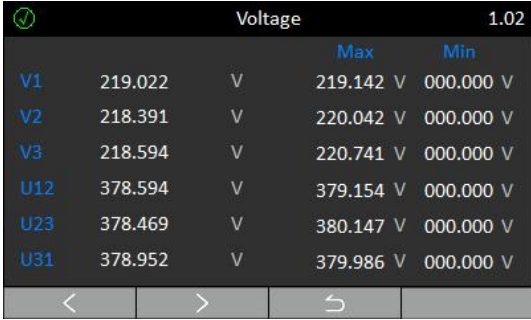
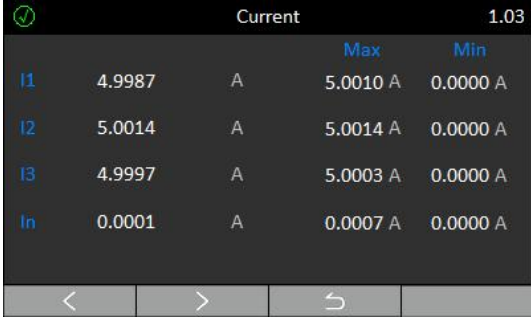
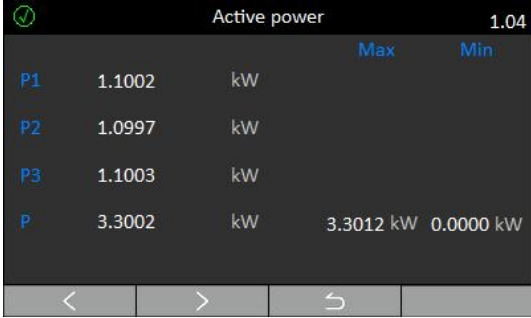
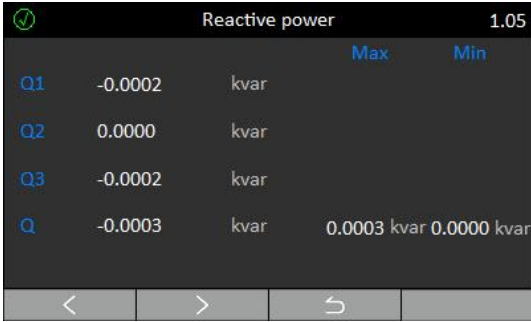
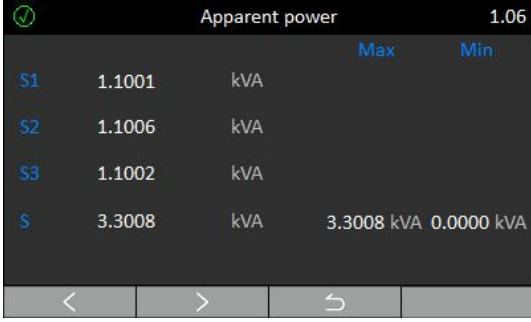
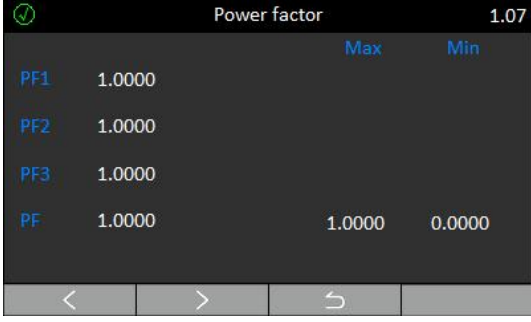
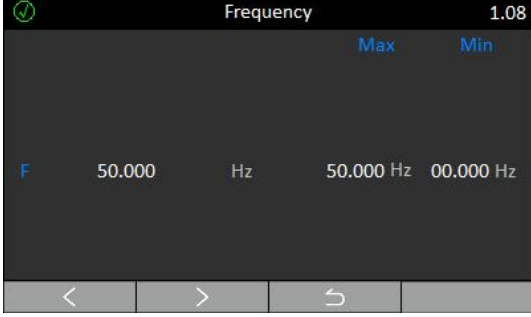

Figure 4.2.1 Overview of Display Menu

4.2.2 Display Features

4.2.2.1 Real-time measurement



No.	Display	Description																																																						
1	 <p>Real-time overview 1.01</p> <table border="1"> <tr> <td>V1</td> <td>219.022</td> <td>V</td> <td>P1</td> <td>1.092</td> <td>kW</td> </tr> <tr> <td>V2</td> <td>218.391</td> <td>V</td> <td>P2</td> <td>1.087</td> <td>kW</td> </tr> <tr> <td>V3</td> <td>218.594</td> <td>V</td> <td>P3</td> <td>1.093</td> <td>kW</td> </tr> <tr> <td>U12</td> <td>378.594</td> <td>V</td> <td>PF1</td> <td>1.000</td> <td></td> </tr> <tr> <td>U23</td> <td>378.469</td> <td>V</td> <td>PF2</td> <td>1.000</td> <td></td> </tr> <tr> <td>U31</td> <td>378.952</td> <td>V</td> <td>PF2</td> <td>1.000</td> <td></td> </tr> <tr> <td>I1</td> <td>4.9888</td> <td>A</td> <td>Q</td> <td>-0.003</td> <td>kvar</td> </tr> <tr> <td>I2</td> <td>4.9806</td> <td>A</td> <td>S</td> <td>3.273</td> <td>kVA</td> </tr> <tr> <td>I3</td> <td>5.0033</td> <td>A</td> <td>F</td> <td>49.998</td> <td>Hz</td> </tr> </table>	V1	219.022	V	P1	1.092	kW	V2	218.391	V	P2	1.087	kW	V3	218.594	V	P3	1.093	kW	U12	378.594	V	PF1	1.000		U23	378.469	V	PF2	1.000		U31	378.952	V	PF2	1.000		I1	4.9888	A	Q	-0.003	kvar	I2	4.9806	A	S	3.273	kVA	I3	5.0033	A	F	49.998	Hz	Real-time measurement overview
V1	219.022	V	P1	1.092	kW																																																			
V2	218.391	V	P2	1.087	kW																																																			
V3	218.594	V	P3	1.093	kW																																																			
U12	378.594	V	PF1	1.000																																																				
U23	378.469	V	PF2	1.000																																																				
U31	378.952	V	PF2	1.000																																																				
I1	4.9888	A	Q	-0.003	kvar																																																			
I2	4.9806	A	S	3.273	kVA																																																			
I3	5.0033	A	F	49.998	Hz																																																			
2	 <p>Voltage 1.02</p> <table border="1"> <thead> <tr> <th></th> <th></th> <th></th> <th>Max</th> <th>Min</th> </tr> </thead> <tbody> <tr> <td>V1</td> <td>219.022</td> <td>V</td> <td>219.142 V</td> <td>000.000 V</td> </tr> <tr> <td>V2</td> <td>218.391</td> <td>V</td> <td>220.042 V</td> <td>000.000 V</td> </tr> <tr> <td>V3</td> <td>218.594</td> <td>V</td> <td>220.741 V</td> <td>000.000 V</td> </tr> <tr> <td>U12</td> <td>378.594</td> <td>V</td> <td>379.154 V</td> <td>000.000 V</td> </tr> <tr> <td>U23</td> <td>378.469</td> <td>V</td> <td>380.147 V</td> <td>000.000 V</td> </tr> <tr> <td>U31</td> <td>378.952</td> <td>V</td> <td>379.986 V</td> <td>000.000 V</td> </tr> </tbody> </table>				Max	Min	V1	219.022	V	219.142 V	000.000 V	V2	218.391	V	220.042 V	000.000 V	V3	218.594	V	220.741 V	000.000 V	U12	378.594	V	379.154 V	000.000 V	U23	378.469	V	380.147 V	000.000 V	U31	378.952	V	379.986 V	000.000 V	<p>Voltage</p> <p>Phase to neutral voltage</p> <p>V1=219.022V</p> <p>V2=218.391V</p> <p>V3=218.594V</p> <p>Phase to phase voltage</p> <p>U12=378.594V</p> <p>U23=378.469V</p> <p>U31=378.952V</p>																			
			Max	Min																																																				
V1	219.022	V	219.142 V	000.000 V																																																				
V2	218.391	V	220.042 V	000.000 V																																																				
V3	218.594	V	220.741 V	000.000 V																																																				
U12	378.594	V	379.154 V	000.000 V																																																				
U23	378.469	V	380.147 V	000.000 V																																																				
U31	378.952	V	379.986 V	000.000 V																																																				
3	 <p>Current 1.03</p> <table border="1"> <thead> <tr> <th></th> <th></th> <th></th> <th>Max</th> <th>Min</th> </tr> </thead> <tbody> <tr> <td>I1</td> <td>4.9987</td> <td>A</td> <td>5.0010 A</td> <td>0.0000 A</td> </tr> <tr> <td>I2</td> <td>5.0014</td> <td>A</td> <td>5.0014 A</td> <td>0.0000 A</td> </tr> <tr> <td>I3</td> <td>4.9997</td> <td>A</td> <td>5.0003 A</td> <td>0.0000 A</td> </tr> <tr> <td>In</td> <td>0.0001</td> <td>A</td> <td>0.0007 A</td> <td>0.0000 A</td> </tr> </tbody> </table>				Max	Min	I1	4.9987	A	5.0010 A	0.0000 A	I2	5.0014	A	5.0014 A	0.0000 A	I3	4.9997	A	5.0003 A	0.0000 A	In	0.0001	A	0.0007 A	0.0000 A	<p>Current</p> <p>I1=4.9987A</p> <p>I2=5.0014A</p> <p>I3=4.9997A</p> <p>Neutral current</p> <p>In=0.0001A</p>																													
			Max	Min																																																				
I1	4.9987	A	5.0010 A	0.0000 A																																																				
I2	5.0014	A	5.0014 A	0.0000 A																																																				
I3	4.9997	A	5.0003 A	0.0000 A																																																				
In	0.0001	A	0.0007 A	0.0000 A																																																				
4	 <p>Active power 1.04</p> <table border="1"> <thead> <tr> <th></th> <th></th> <th></th> <th>Max</th> <th>Min</th> </tr> </thead> <tbody> <tr> <td>P1</td> <td>1.1002</td> <td>kW</td> <td></td> <td></td> </tr> <tr> <td>P2</td> <td>1.0997</td> <td>kW</td> <td></td> <td></td> </tr> <tr> <td>P3</td> <td>1.1003</td> <td>kW</td> <td></td> <td></td> </tr> <tr> <td>P</td> <td>3.3002</td> <td>kW</td> <td>3.3012 kW</td> <td>0.0000 kW</td> </tr> </tbody> </table>				Max	Min	P1	1.1002	kW			P2	1.0997	kW			P3	1.1003	kW			P	3.3002	kW	3.3012 kW	0.0000 kW	<p>Active power</p> <p>P1 =1.1002kW</p> <p>P2=1.0997kW</p> <p>P3=1.1003kW</p> <p>P= 3.3002kW</p>																													
			Max	Min																																																				
P1	1.1002	kW																																																						
P2	1.0997	kW																																																						
P3	1.1003	kW																																																						
P	3.3002	kW	3.3012 kW	0.0000 kW																																																				



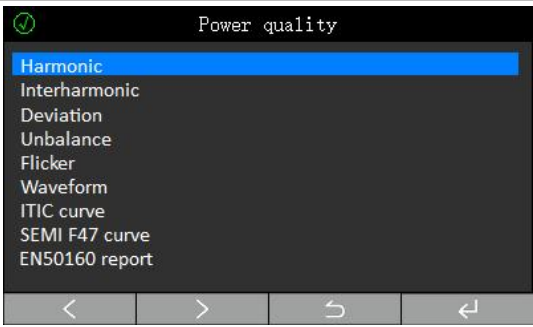
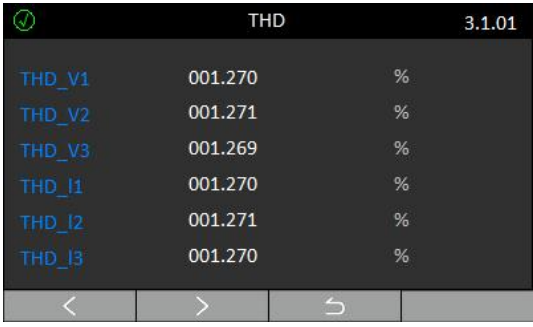
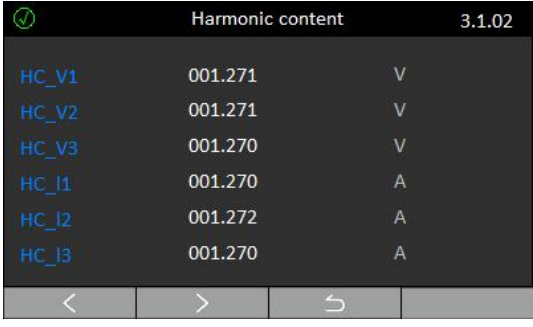

5	 <p>Reactive power 1.05</p> <p>Max Min</p> <p>Q1 -0.0002 kvar</p> <p>Q2 0.0000 kvar</p> <p>Q3 -0.0002 kvar</p> <p>Q -0.0003 kvar 0.0003 kvar 0.0000 kvar</p>	<p>Reactive power</p> <p>Q1=-0.002kvar</p> <p>Q2=0.000kvar</p> <p>Q3=-0.002kvar</p> <p>Q=-0.003kvar</p>
6	 <p>Apparent power 1.06</p> <p>Max Min</p> <p>S1 1.1001 kVA</p> <p>S2 1.1006 kVA</p> <p>S3 1.1002 kVA</p> <p>S 3.3008 kVA 3.3008 kVA 0.0000 kVA</p>	<p>Apparent power</p> <p>S1=1.1001kVA</p> <p>S2=1.1006kVA</p> <p>S3=1.1002kVA</p> <p>S=3.3008kVA</p>
7	 <p>Power factor 1.07</p> <p>Max Min</p> <p>PF1 1.0000</p> <p>PF2 1.0000</p> <p>PF3 1.0000</p> <p>PF 1.0000 1.0000 0.0000</p>	<p>Power factor</p> <p>PF1=1.000</p> <p>PF2=1.000</p> <p>PF3=1.000</p> <p>PF=1.000</p>
8	 <p>Frequency 1.08</p> <p>Max Min</p> <p>F 50.000 Hz 50.000 Hz 00.000 Hz</p>	<p>Frequency</p> <p>F=50.000Hz</p>

4.2.2.2 Energy metering

No.	Display	Description																											
1	<p>Energy overview 2.01</p> <table border="1"> <tr><td>EP+</td><td>0000000007.994</td><td>kWh</td></tr> <tr><td>EP-</td><td>0000000000.965</td><td>kWh</td></tr> <tr><td>EQ+</td><td>0000000001.671</td><td>kvarh</td></tr> <tr><td>EQ-</td><td>0000000005.210</td><td>kvarh</td></tr> <tr><td>ES</td><td>0000000015.809</td><td>kVAh</td></tr> <tr><td>EQ1</td><td>0000000001.650</td><td>kvarh</td></tr> <tr><td>EQ2</td><td>0000000000.021</td><td>kvarh</td></tr> <tr><td>EQ3</td><td>0000000000.000</td><td>kvarh</td></tr> <tr><td>EQ4</td><td>0000000000.000</td><td>kvarh</td></tr> </table>	EP+	0000000007.994	kWh	EP-	0000000000.965	kWh	EQ+	0000000001.671	kvarh	EQ-	0000000005.210	kvarh	ES	0000000015.809	kVAh	EQ1	0000000001.650	kvarh	EQ2	0000000000.021	kvarh	EQ3	0000000000.000	kvarh	EQ4	0000000000.000	kvarh	Energy overview
EP+	0000000007.994	kWh																											
EP-	0000000000.965	kWh																											
EQ+	0000000001.671	kvarh																											
EQ-	0000000005.210	kvarh																											
ES	0000000015.809	kVAh																											
EQ1	0000000001.650	kvarh																											
EQ2	0000000000.021	kvarh																											
EQ3	0000000000.000	kvarh																											
EQ4	0000000000.000	kvarh																											
2	<p>L1 energy 2.02</p> <table border="1"> <tr><td>EP+</td><td>0000000002.672</td><td>kWh</td></tr> <tr><td>EP-</td><td>0000000000.322</td><td>kWh</td></tr> <tr><td>EQ+</td><td>0000000000.550</td><td>kvarh</td></tr> <tr><td>EQ-</td><td>0000000001.739</td><td>kvarh</td></tr> </table>	EP+	0000000002.672	kWh	EP-	0000000000.322	kWh	EQ+	0000000000.550	kvarh	EQ-	0000000001.739	kvarh	<p>L1 energy</p> <p>Import active energy EP+ = 2.672kWh</p> <p>Export active energy EP- = 0.322kWh</p> <p>Import reactive energy EP+ = 4.284kvarh</p> <p>Export reactive energy EP- = 1.814kvarh</p>															
EP+	0000000002.672	kWh																											
EP-	0000000000.322	kWh																											
EQ+	0000000000.550	kvarh																											
EQ-	0000000001.739	kvarh																											
3	<p>Fundamental energy 2.05</p> <table border="1"> <tr><td>EP+</td><td>0000000007.964</td><td>kWh</td></tr> <tr><td>EP-</td><td>0000000000.949</td><td>kWh</td></tr> <tr><td>EQ+</td><td>0000000001.651</td><td>kvarh</td></tr> <tr><td>EQ-</td><td>0000000000.000</td><td>kvarh</td></tr> </table>	EP+	0000000007.964	kWh	EP-	0000000000.949	kWh	EQ+	0000000001.651	kvarh	EQ-	0000000000.000	kvarh	<p>Fundamental energy</p> <p>Fundamental import active energy EP+ = 7.964kWh</p> <p>Fundamental export active energy EP- = 0.949kWh</p> <p>Fundamental import reactive energy EQ+ = 1.651kvarh</p> <p>Fundamental export reactive energy EQ- = 0.000kvarh</p>															
EP+	0000000007.964	kWh																											
EP-	0000000000.949	kWh																											
EQ+	0000000001.651	kvarh																											
EQ-	0000000000.000	kvarh																											
4	<p>Tariff energy 2.06</p> <table border="1"> <tr><td>T1</td><td>00000000117.952</td><td>kWh</td></tr> <tr><td>T2</td><td>00000000117.952</td><td>kWh</td></tr> <tr><td>T3</td><td>0000000000.000</td><td>kWh</td></tr> <tr><td>T4</td><td>0000000000.000</td><td>kWh</td></tr> <tr><td>T5</td><td>0000000000.000</td><td>kWh</td></tr> <tr><td>T6</td><td>0000000000.000</td><td>kWh</td></tr> <tr><td>T7</td><td>0000000000.000</td><td>kWh</td></tr> <tr><td>T8</td><td>0000000000.000</td><td>kWh</td></tr> </table>	T1	00000000117.952	kWh	T2	00000000117.952	kWh	T3	0000000000.000	kWh	T4	0000000000.000	kWh	T5	0000000000.000	kWh	T6	0000000000.000	kWh	T7	0000000000.000	kWh	T8	0000000000.000	kWh	<p>Tariff energy</p> <p>8 tariffs energy</p>			
T1	00000000117.952	kWh																											
T2	00000000117.952	kWh																											
T3	0000000000.000	kWh																											
T4	0000000000.000	kWh																											
T5	0000000000.000	kWh																											
T6	0000000000.000	kWh																											
T7	0000000000.000	kWh																											
T8	0000000000.000	kWh																											

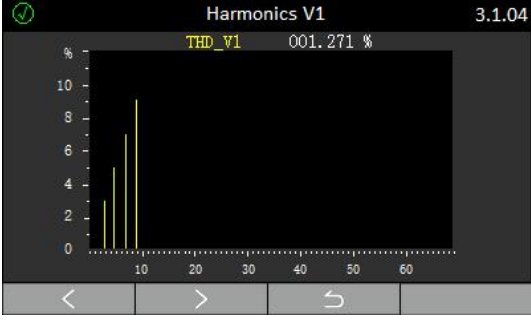
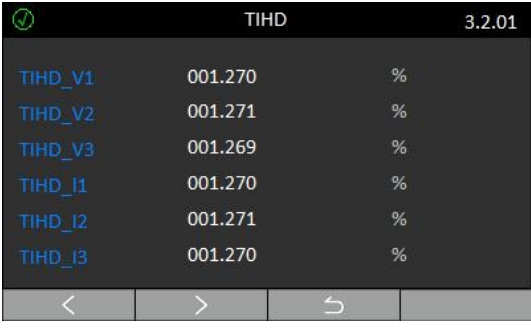
4.2.2.3 Power quality

No.	Display	Description																																																							
1	 <p>Power quality</p> <ul style="list-style-type: none"> Harmonic Interharmonic Deviation Unbalance Flicker Waveform ITIC curve SEMI F47 curve EN50160 report 	Power quality overview																																																							
2	 <p>THD 3.1.01</p> <table border="1"> <tr><td>THD_V1</td><td>001.270</td><td>%</td></tr> <tr><td>THD_V2</td><td>001.271</td><td>%</td></tr> <tr><td>THD_V3</td><td>001.269</td><td>%</td></tr> <tr><td>THD_I1</td><td>001.270</td><td>%</td></tr> <tr><td>THD_I2</td><td>001.271</td><td>%</td></tr> <tr><td>THD_I3</td><td>001.270</td><td>%</td></tr> </table>	THD_V1	001.270	%	THD_V2	001.271	%	THD_V3	001.269	%	THD_I1	001.270	%	THD_I2	001.271	%	THD_I3	001.270	%	Total harmonic distortion(THD)																																					
THD_V1	001.270	%																																																							
THD_V2	001.271	%																																																							
THD_V3	001.269	%																																																							
THD_I1	001.270	%																																																							
THD_I2	001.271	%																																																							
THD_I3	001.270	%																																																							
3	 <p>Harmonic content 3.1.02</p> <table border="1"> <tr><td>HC_V1</td><td>001.271</td><td>V</td></tr> <tr><td>HC_V2</td><td>001.271</td><td>V</td></tr> <tr><td>HC_V3</td><td>001.270</td><td>V</td></tr> <tr><td>HC_I1</td><td>001.270</td><td>A</td></tr> <tr><td>HC_I2</td><td>001.272</td><td>A</td></tr> <tr><td>HC_I3</td><td>001.270</td><td>A</td></tr> </table>	HC_V1	001.271	V	HC_V2	001.271	V	HC_V3	001.270	V	HC_I1	001.270	A	HC_I2	001.272	A	HC_I3	001.270	A	Harmonic content																																					
HC_V1	001.271	V																																																							
HC_V2	001.271	V																																																							
HC_V3	001.270	V																																																							
HC_I1	001.270	A																																																							
HC_I2	001.272	A																																																							
HC_I3	001.270	A																																																							
4	 <p>Harmonic ratio 3.1.03</p> <table border="1"> <thead> <tr> <th>h</th> <th>V1</th> <th>V3</th> <th>I1</th> <th>I3</th> </tr> </thead> <tbody> <tr><td>02</td><td>00.000</td><td>00.000</td><td>00.000</td><td>00.000</td></tr> <tr><td>03</td><td>02.987</td><td>02.988</td><td>03.004</td><td>02.997</td></tr> <tr><td>04</td><td>00.000</td><td>00.000</td><td>00.000</td><td>00.000</td></tr> <tr><td>05</td><td>04.982</td><td>04.987</td><td>05.004</td><td>05.000</td></tr> <tr><td>06</td><td>00.000</td><td>00.000</td><td>00.000</td><td>00.000</td></tr> <tr><td>07</td><td>06.966</td><td>06.962</td><td>07.024</td><td>07.016</td></tr> <tr><td>08</td><td>00.000</td><td>00.000</td><td>00.000</td><td>00.000</td></tr> <tr><td>09</td><td>08.907</td><td>08.912</td><td>09.049</td><td>09.036</td></tr> <tr><td>10</td><td>00.000</td><td>00.000</td><td>00.000</td><td>00.000</td></tr> <tr><td>11</td><td>00.000</td><td>00.000</td><td>00.000</td><td>00.000</td></tr> </tbody> </table>	h	V1	V3	I1	I3	02	00.000	00.000	00.000	00.000	03	02.987	02.988	03.004	02.997	04	00.000	00.000	00.000	00.000	05	04.982	04.987	05.004	05.000	06	00.000	00.000	00.000	00.000	07	06.966	06.962	07.024	07.016	08	00.000	00.000	00.000	00.000	09	08.907	08.912	09.049	09.036	10	00.000	00.000	00.000	00.000	11	00.000	00.000	00.000	00.000	Harmonic ratio
h	V1	V3	I1	I3																																																					
02	00.000	00.000	00.000	00.000																																																					
03	02.987	02.988	03.004	02.997																																																					
04	00.000	00.000	00.000	00.000																																																					
05	04.982	04.987	05.004	05.000																																																					
06	00.000	00.000	00.000	00.000																																																					
07	06.966	06.962	07.024	07.016																																																					
08	00.000	00.000	00.000	00.000																																																					
09	08.907	08.912	09.049	09.036																																																					
10	00.000	00.000	00.000	00.000																																																					
11	00.000	00.000	00.000	00.000																																																					
5	 <p>Harmonic ratio 3.1.03</p> <table border="1"> <thead> <tr> <th>h</th> <th>V1</th> <th>V3</th> <th>I1</th> <th>I3</th> </tr> </thead> <tbody> <tr><td>08</td><td>00.000</td><td>00.000</td><td>00.000</td><td>00.000</td></tr> <tr><td>09</td><td>08.907</td><td>08.912</td><td>09.049</td><td>09.036</td></tr> <tr><td>10</td><td>00.000</td><td>00.000</td><td>00.000</td><td>00.000</td></tr> <tr><td>11</td><td>00.000</td><td>00.000</td><td>00.000</td><td>00.000</td></tr> <tr><td>12</td><td>00.000</td><td>00.000</td><td>00.000</td><td>00.000</td></tr> <tr><td>13</td><td>00.000</td><td>00.000</td><td>00.000</td><td>00.000</td></tr> <tr><td>14</td><td>00.000</td><td>00.000</td><td>00.000</td><td>00.000</td></tr> <tr><td>15</td><td>00.000</td><td>00.000</td><td>00.000</td><td>00.000</td></tr> <tr><td>16</td><td>00.000</td><td>00.000</td><td>00.000</td><td>00.000</td></tr> <tr><td>17</td><td>00.000</td><td>00.000</td><td>00.000</td><td>00.000</td></tr> </tbody> </table>	h	V1	V3	I1	I3	08	00.000	00.000	00.000	00.000	09	08.907	08.912	09.049	09.036	10	00.000	00.000	00.000	00.000	11	00.000	00.000	00.000	00.000	12	00.000	00.000	00.000	00.000	13	00.000	00.000	00.000	00.000	14	00.000	00.000	00.000	00.000	15	00.000	00.000	00.000	00.000	16	00.000	00.000	00.000	00.000	17	00.000	00.000	00.000	00.000	Harmonic ratio
h	V1	V3	I1	I3																																																					
08	00.000	00.000	00.000	00.000																																																					
09	08.907	08.912	09.049	09.036																																																					
10	00.000	00.000	00.000	00.000																																																					
11	00.000	00.000	00.000	00.000																																																					
12	00.000	00.000	00.000	00.000																																																					
13	00.000	00.000	00.000	00.000																																																					
14	00.000	00.000	00.000	00.000																																																					
15	00.000	00.000	00.000	00.000																																																					
16	00.000	00.000	00.000	00.000																																																					
17	00.000	00.000	00.000	00.000																																																					

6	 <p>Harmonics V1 3.1.04 THD_V1 001.271 %</p>	Harmonic bar																																																																		
7	 <p>TIHD 3.2.01</p> <table border="1"> <tr><td>TIHD_V1</td><td>001.270</td><td>%</td></tr> <tr><td>TIHD_V2</td><td>001.271</td><td>%</td></tr> <tr><td>TIHD_V3</td><td>001.269</td><td>%</td></tr> <tr><td>TIHD_I1</td><td>001.270</td><td>%</td></tr> <tr><td>TIHD_I2</td><td>001.271</td><td>%</td></tr> <tr><td>TIHD_I3</td><td>001.270</td><td>%</td></tr> </table>	TIHD_V1	001.270	%	TIHD_V2	001.271	%	TIHD_V3	001.269	%	TIHD_I1	001.270	%	TIHD_I2	001.271	%	TIHD_I3	001.270	%	Total Inter-harmonic distortion																																																
TIHD_V1	001.270	%																																																																		
TIHD_V2	001.271	%																																																																		
TIHD_V3	001.269	%																																																																		
TIHD_I1	001.270	%																																																																		
TIHD_I2	001.271	%																																																																		
TIHD_I3	001.270	%																																																																		
8	 <p>Inter-harmonic content 3.2.02</p> <table border="1"> <tr><td>IHC_V1</td><td>002.794</td><td>V</td></tr> <tr><td>IHC_V2</td><td>002.796</td><td>V</td></tr> <tr><td>IHC_V3</td><td>002.793</td><td>V</td></tr> <tr><td>IHC_I1</td><td>000.635</td><td>A</td></tr> <tr><td>IHC_I2</td><td>000.637</td><td>A</td></tr> <tr><td>IHC_I3</td><td>000.636</td><td>A</td></tr> </table>	IHC_V1	002.794	V	IHC_V2	002.796	V	IHC_V3	002.793	V	IHC_I1	000.635	A	IHC_I2	000.637	A	IHC_I3	000.636	A	Inter-harmonic content																																																
IHC_V1	002.794	V																																																																		
IHC_V2	002.796	V																																																																		
IHC_V3	002.793	V																																																																		
IHC_I1	000.635	A																																																																		
IHC_I2	000.637	A																																																																		
IHC_I3	000.636	A																																																																		
9	 <p>Interharmonic ratio 3.2.03</p> <table border="1"> <thead> <tr><th>ih</th><th>V1</th><th>V3</th><th>I1</th><th>I2</th><th>I3</th></tr> </thead> <tbody> <tr><td>02</td><td>00.000</td><td>00.000</td><td>00.000</td><td>00.000</td><td>00.000</td></tr> <tr><td>03</td><td>02.987</td><td>02.988</td><td>03.004</td><td>02.997</td><td>03.000</td></tr> <tr><td>04</td><td>00.000</td><td>00.000</td><td>00.000</td><td>00.000</td><td>00.000</td></tr> <tr><td>05</td><td>04.982</td><td>04.987</td><td>05.004</td><td>05.000</td><td>05.000</td></tr> <tr><td>06</td><td>00.000</td><td>00.000</td><td>00.000</td><td>00.000</td><td>00.000</td></tr> <tr><td>07</td><td>06.966</td><td>06.962</td><td>07.024</td><td>07.018</td><td>07.022</td></tr> <tr><td>08</td><td>00.000</td><td>00.000</td><td>00.000</td><td>00.000</td><td>00.000</td></tr> <tr><td>09</td><td>08.907</td><td>08.912</td><td>09.049</td><td>09.036</td><td>09.044</td></tr> <tr><td>10</td><td>00.000</td><td>00.000</td><td>00.000</td><td>00.000</td><td>00.000</td></tr> <tr><td>11</td><td>00.000</td><td>00.000</td><td>00.000</td><td>00.000</td><td>00.000</td></tr> </tbody> </table>	ih	V1	V3	I1	I2	I3	02	00.000	00.000	00.000	00.000	00.000	03	02.987	02.988	03.004	02.997	03.000	04	00.000	00.000	00.000	00.000	00.000	05	04.982	04.987	05.004	05.000	05.000	06	00.000	00.000	00.000	00.000	00.000	07	06.966	06.962	07.024	07.018	07.022	08	00.000	00.000	00.000	00.000	00.000	09	08.907	08.912	09.049	09.036	09.044	10	00.000	00.000	00.000	00.000	00.000	11	00.000	00.000	00.000	00.000	00.000	Inter-harmonic ratio
ih	V1	V3	I1	I2	I3																																																															
02	00.000	00.000	00.000	00.000	00.000																																																															
03	02.987	02.988	03.004	02.997	03.000																																																															
04	00.000	00.000	00.000	00.000	00.000																																																															
05	04.982	04.987	05.004	05.000	05.000																																																															
06	00.000	00.000	00.000	00.000	00.000																																																															
07	06.966	06.962	07.024	07.018	07.022																																																															
08	00.000	00.000	00.000	00.000	00.000																																																															
09	08.907	08.912	09.049	09.036	09.044																																																															
10	00.000	00.000	00.000	00.000	00.000																																																															
11	00.000	00.000	00.000	00.000	00.000																																																															
10	 <p>Interharmonic ratio 3.2.03</p> <table border="1"> <thead> <tr><th>ih</th><th>V1</th><th>V3</th><th>I1</th><th>I2</th><th>I3</th></tr> </thead> <tbody> <tr><td>08</td><td>00.000</td><td>00.000</td><td>00.000</td><td>00.000</td><td>00.000</td></tr> <tr><td>09</td><td>08.907</td><td>08.912</td><td>09.049</td><td>09.036</td><td>09.044</td></tr> <tr><td>10</td><td>00.000</td><td>00.000</td><td>00.000</td><td>00.000</td><td>00.000</td></tr> <tr><td>11</td><td>00.000</td><td>00.000</td><td>00.000</td><td>00.000</td><td>00.000</td></tr> <tr><td>12</td><td>00.000</td><td>00.000</td><td>00.000</td><td>00.000</td><td>00.000</td></tr> <tr><td>13</td><td>00.000</td><td>00.000</td><td>00.000</td><td>00.000</td><td>00.000</td></tr> <tr><td>14</td><td>00.000</td><td>00.000</td><td>00.000</td><td>00.000</td><td>00.000</td></tr> <tr><td>15</td><td>00.000</td><td>00.000</td><td>00.000</td><td>00.000</td><td>00.000</td></tr> <tr><td>16</td><td>00.000</td><td>00.000</td><td>00.000</td><td>00.000</td><td>00.000</td></tr> <tr><td>17</td><td>00.000</td><td>00.000</td><td>00.000</td><td>00.000</td><td>00.000</td></tr> </tbody> </table>	ih	V1	V3	I1	I2	I3	08	00.000	00.000	00.000	00.000	00.000	09	08.907	08.912	09.049	09.036	09.044	10	00.000	00.000	00.000	00.000	00.000	11	00.000	00.000	00.000	00.000	00.000	12	00.000	00.000	00.000	00.000	00.000	13	00.000	00.000	00.000	00.000	00.000	14	00.000	00.000	00.000	00.000	00.000	15	00.000	00.000	00.000	00.000	00.000	16	00.000	00.000	00.000	00.000	00.000	17	00.000	00.000	00.000	00.000	00.000	Inter-harmonic ratio
ih	V1	V3	I1	I2	I3																																																															
08	00.000	00.000	00.000	00.000	00.000																																																															
09	08.907	08.912	09.049	09.036	09.044																																																															
10	00.000	00.000	00.000	00.000	00.000																																																															
11	00.000	00.000	00.000	00.000	00.000																																																															
12	00.000	00.000	00.000	00.000	00.000																																																															
13	00.000	00.000	00.000	00.000	00.000																																																															
14	00.000	00.000	00.000	00.000	00.000																																																															
15	00.000	00.000	00.000	00.000	00.000																																																															
16	00.000	00.000	00.000	00.000	00.000																																																															
17	00.000	00.000	00.000	00.000	00.000																																																															

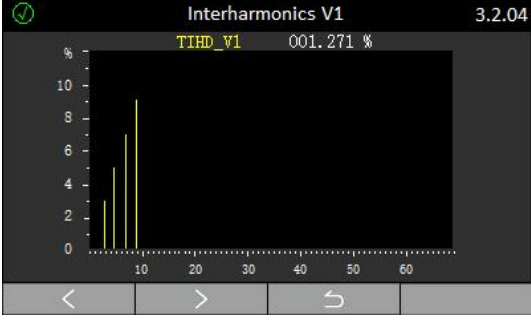
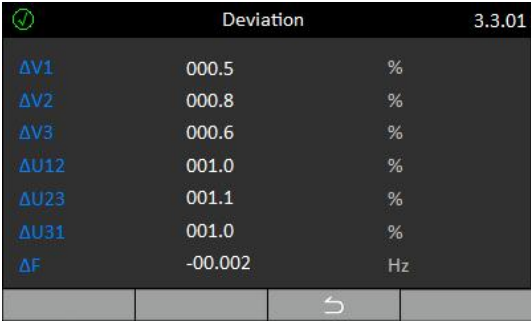
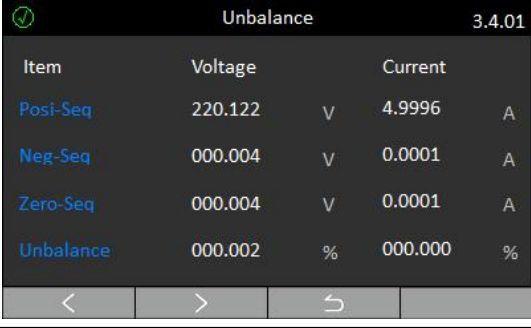
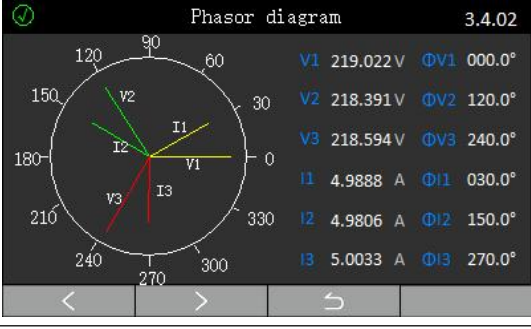
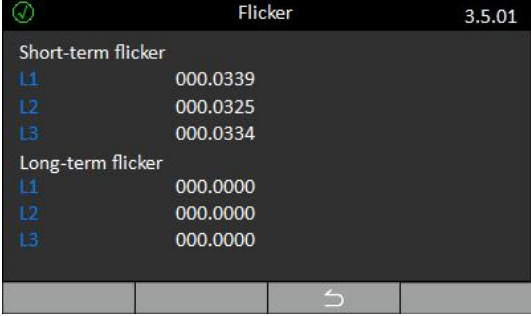
11		Inter-harmonic bar																								
12	 <table border="1"> <thead> <tr> <th>Item</th> <th>Value</th> <th>Unit</th> </tr> </thead> <tbody> <tr> <td>$\Delta V1$</td> <td>000.5</td> <td>%</td> </tr> <tr> <td>$\Delta V2$</td> <td>000.8</td> <td>%</td> </tr> <tr> <td>$\Delta V3$</td> <td>000.6</td> <td>%</td> </tr> <tr> <td>$\Delta U12$</td> <td>001.0</td> <td>%</td> </tr> <tr> <td>$\Delta U23$</td> <td>001.1</td> <td>%</td> </tr> <tr> <td>$\Delta U31$</td> <td>001.0</td> <td>%</td> </tr> <tr> <td>ΔF</td> <td>-00.002</td> <td>Hz</td> </tr> </tbody> </table>	Item	Value	Unit	$\Delta V1$	000.5	%	$\Delta V2$	000.8	%	$\Delta V3$	000.6	%	$\Delta U12$	001.0	%	$\Delta U23$	001.1	%	$\Delta U31$	001.0	%	ΔF	-00.002	Hz	Voltage deviation Frequency deviation
Item	Value	Unit																								
$\Delta V1$	000.5	%																								
$\Delta V2$	000.8	%																								
$\Delta V3$	000.6	%																								
$\Delta U12$	001.0	%																								
$\Delta U23$	001.1	%																								
$\Delta U31$	001.0	%																								
ΔF	-00.002	Hz																								
13	 <table border="1"> <thead> <tr> <th>Item</th> <th>Voltage</th> <th>Current</th> </tr> </thead> <tbody> <tr> <td>Posi-Seq</td> <td>220.122 V</td> <td>4.9996 A</td> </tr> <tr> <td>Neg-Seq</td> <td>000.004 V</td> <td>0.0001 A</td> </tr> <tr> <td>Zero-Seq</td> <td>000.004 V</td> <td>0.0001 A</td> </tr> <tr> <td>Unbalance</td> <td>000.002 %</td> <td>000.000 %</td> </tr> </tbody> </table>	Item	Voltage	Current	Posi-Seq	220.122 V	4.9996 A	Neg-Seq	000.004 V	0.0001 A	Zero-Seq	000.004 V	0.0001 A	Unbalance	000.002 %	000.000 %	Unbalance									
Item	Voltage	Current																								
Posi-Seq	220.122 V	4.9996 A																								
Neg-Seq	000.004 V	0.0001 A																								
Zero-Seq	000.004 V	0.0001 A																								
Unbalance	000.002 %	000.000 %																								
14	 <table border="1"> <thead> <tr> <th>Item</th> <th>Value</th> <th>Phase</th> </tr> </thead> <tbody> <tr> <td>V1</td> <td>219.022 V</td> <td>$\Phi V1$ 000.0°</td> </tr> <tr> <td>V2</td> <td>218.391 V</td> <td>$\Phi V2$ 120.0°</td> </tr> <tr> <td>V3</td> <td>218.594 V</td> <td>$\Phi V3$ 240.0°</td> </tr> <tr> <td>I1</td> <td>4.9888 A</td> <td>$\Phi I1$ 030.0°</td> </tr> <tr> <td>I2</td> <td>4.9806 A</td> <td>$\Phi I2$ 150.0°</td> </tr> <tr> <td>I3</td> <td>5.0033 A</td> <td>$\Phi I3$ 270.0°</td> </tr> </tbody> </table>	Item	Value	Phase	V1	219.022 V	$\Phi V1$ 000.0°	V2	218.391 V	$\Phi V2$ 120.0°	V3	218.594 V	$\Phi V3$ 240.0°	I1	4.9888 A	$\Phi I1$ 030.0°	I2	4.9806 A	$\Phi I2$ 150.0°	I3	5.0033 A	$\Phi I3$ 270.0°	Phasor diagram			
Item	Value	Phase																								
V1	219.022 V	$\Phi V1$ 000.0°																								
V2	218.391 V	$\Phi V2$ 120.0°																								
V3	218.594 V	$\Phi V3$ 240.0°																								
I1	4.9888 A	$\Phi I1$ 030.0°																								
I2	4.9806 A	$\Phi I2$ 150.0°																								
I3	5.0033 A	$\Phi I3$ 270.0°																								
15	 <table border="1"> <thead> <tr> <th>Category</th> <th>Item</th> <th>Value</th> </tr> </thead> <tbody> <tr> <td rowspan="3">Short-term flicker</td> <td>L1</td> <td>000.0339</td> </tr> <tr> <td>L2</td> <td>000.0325</td> </tr> <tr> <td>L3</td> <td>000.0334</td> </tr> <tr> <td rowspan="3">Long-term flicker</td> <td>L1</td> <td>000.0000</td> </tr> <tr> <td>L2</td> <td>000.0000</td> </tr> <tr> <td>L3</td> <td>000.0000</td> </tr> </tbody> </table>	Category	Item	Value	Short-term flicker	L1	000.0339	L2	000.0325	L3	000.0334	Long-term flicker	L1	000.0000	L2	000.0000	L3	000.0000	Flicker							
Category	Item	Value																								
Short-term flicker	L1	000.0339																								
	L2	000.0325																								
	L3	000.0334																								
Long-term flicker	L1	000.0000																								
	L2	000.0000																								
	L3	000.0000																								

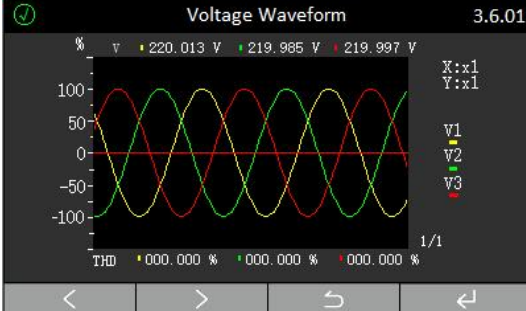
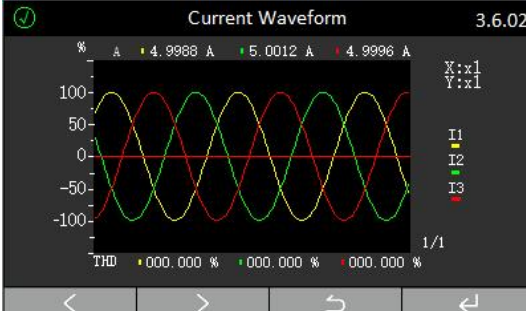
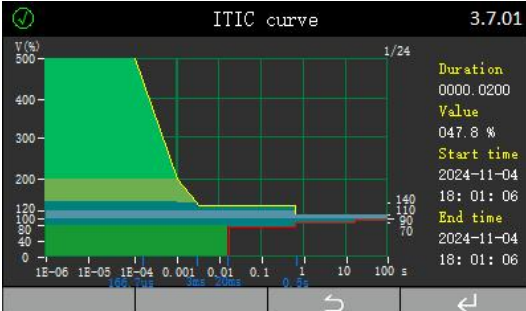
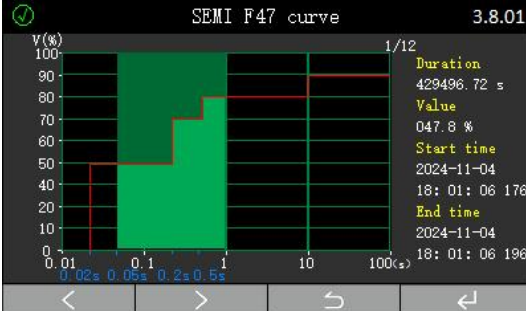
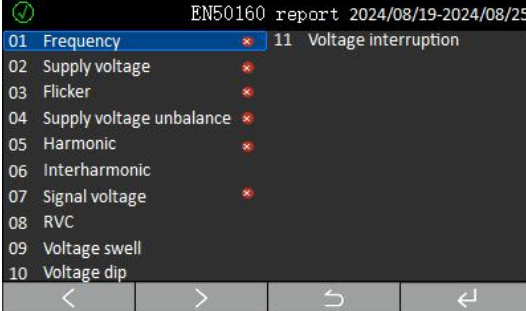
16	 <p>Voltage Waveform 3.6.01</p> <p>% V • 220.013 V • 219.985 V • 219.997 V</p> <p>THD • 000.000 % • 000.000 % • 000.000 %</p>	Voltage waveform
17	 <p>Current Waveform 3.6.02</p> <p>% A • 4.9968 A • 5.0012 A • 4.9996 A</p> <p>THD • 000.000 % • 000.000 % • 000.000 %</p>	Current waveform
18	 <p>ITIC curve 3.7.01</p> <p>Duration 0000.0200</p> <p>Value 047.8 %</p> <p>Start time 2024-11-04 18: 01: 06</p> <p>End time 2024-11-04 18: 01: 06</p>	ITIC curve
19	 <p>SEMI F47 curve 3.8.01</p> <p>Duration 429496.72 s</p> <p>Value 047.8 %</p> <p>Start time 2024-11-04 18: 01: 06 176</p> <p>End time 2024-11-04 18: 01: 06 196</p>	SEMI F47 curve
20	 <p>EN50160 report 2024/08/19-2024/08/25</p> <ul style="list-style-type: none"> 01 Frequency × 11 Voltage interruption 02 Supply voltage × 03 Flicker × 04 Supply voltage unbalance × 05 Harmonic × 06 Interharmonic × 07 Signal voltage × 08 RVC 09 Voltage swell 10 Voltage dip 	EN50160 report

ITIC/SEMI F47 Curves

The ITIC and SEMI F47 curves specify the ability of equipment to withstand power supply's voltage disturbances. Their significance lies in being the benchmarks for assessing the tolerance of power equipment to voltage interference and voltage disturbances in power supply systems.

For the ITIC curve interface displayed by the device, the horizontal axis represents the duration of transient voltage event, and the vertical axis represents the voltage percentage (relative to nominal voltage). The upper curve represents the tolerance of equipment to voltage swells, and the lower curve represents the tolerance of equipment to voltage dips. The area between them represents the normal running range. As shown in the figure below, this interface shows the amplitude-duration distribution of a single transient event.

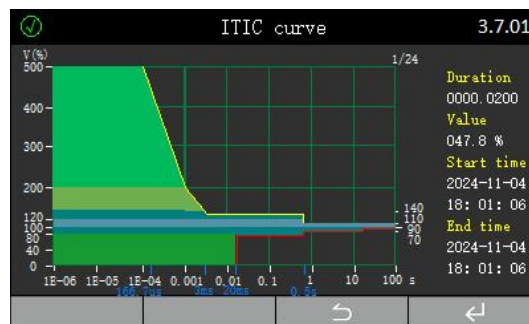

For the SEMI F47 curve interface displayed by the device, the horizontal axis represents the duration of transient voltage event, and the vertical axis represents the voltage percentage (relative to nominal voltage). The specification stipulates the tolerance time of equipment to voltage dips. The area above red solid line represents that the equipment must ensure normal continuous running under such interference. The equipment can run continuously for 0.02s at 0% of the nominal value, 0.2s at 50% of the nominal value, 0.5s at 70% of the nominal value, 1s at 80% of the nominal value, and 10s at 90% of the nominal value. As shown in the figure below, this interface shows the amplitude-duration distribution of a single transient event.

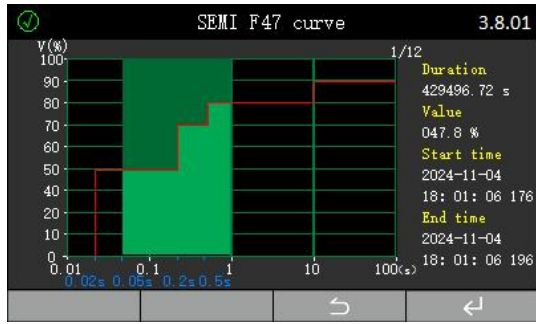

4.2.2.4 Demand

No.	Display	Description																		
1	<p>Present period demand 4.01</p> <table border="1"> <tr><td>I1</td><td>4.9877</td><td>A</td></tr> <tr><td>I2</td><td>4.9794</td><td>A</td></tr> <tr><td>I3</td><td>5.0022</td><td>A</td></tr> <tr><td>P</td><td>3.271</td><td>kW</td></tr> <tr><td>Q</td><td>-0.004</td><td>kvar</td></tr> <tr><td>S</td><td>3.272</td><td>kVA</td></tr> </table>	I1	4.9877	A	I2	4.9794	A	I3	5.0022	A	P	3.271	kW	Q	-0.004	kvar	S	3.272	kVA	<p>Present period demand</p> <p>I1=4.9877A I2=4.9794A I3=5.0022A P=3.271kW Q=-0.004kvar S=3.272kVA</p>
I1	4.9877	A																		
I2	4.9794	A																		
I3	5.0022	A																		
P	3.271	kW																		
Q	-0.004	kvar																		
S	3.272	kVA																		
2	<p>Previous period demand 4.02</p> <table border="1"> <tr><td>I1</td><td>4.9877</td><td>A</td></tr> <tr><td>I2</td><td>4.9794</td><td>A</td></tr> <tr><td>I3</td><td>5.0022</td><td>A</td></tr> <tr><td>P</td><td>3.271</td><td>kW</td></tr> <tr><td>Q</td><td>-0.004</td><td>kvar</td></tr> <tr><td>S</td><td>3.272</td><td>kVA</td></tr> </table>	I1	4.9877	A	I2	4.9794	A	I3	5.0022	A	P	3.271	kW	Q	-0.004	kvar	S	3.272	kVA	<p>Previous period demand</p> <p>I1=4.9877A I2=4.9794A I3=5.0022A P=3.271kW Q=-0.004kvar S=3.272kVA</p>
I1	4.9877	A																		
I2	4.9794	A																		
I3	5.0022	A																		
P	3.271	kW																		
Q	-0.004	kvar																		
S	3.272	kVA																		
3	<p>Forecast demand 4.03</p> <table border="1"> <tr><td>I1</td><td>4.9877</td><td>A</td></tr> <tr><td>I2</td><td>4.9794</td><td>A</td></tr> <tr><td>I3</td><td>4.9999</td><td>A</td></tr> <tr><td>P</td><td>3.271</td><td>kW</td></tr> <tr><td>Q</td><td>-0.004</td><td>kvar</td></tr> <tr><td>S</td><td>3.272</td><td>kVA</td></tr> </table>	I1	4.9877	A	I2	4.9794	A	I3	4.9999	A	P	3.271	kW	Q	-0.004	kvar	S	3.272	kVA	<p>Forecast demand</p> <p>I1=4.9877A I2=4.9794A I3=4.9999A P=3.271kW Q=-0.004kvar S=3.272kVA</p>
I1	4.9877	A																		
I2	4.9794	A																		
I3	4.9999	A																		
P	3.271	kW																		
Q	-0.004	kvar																		
S	3.272	kVA																		
4	<p>Max Demand 4.04</p> <table border="1"> <tr><td>I1</td><td>4.9895</td><td>A</td></tr> <tr><td>I2</td><td>4.9815</td><td>A</td></tr> <tr><td>I3</td><td>5.0049</td><td>A</td></tr> <tr><td>P</td><td>3.273</td><td>kW</td></tr> <tr><td>Q</td><td>0.004</td><td>kvar</td></tr> <tr><td>S</td><td>3.273</td><td>kVA</td></tr> </table>	I1	4.9895	A	I2	4.9815	A	I3	5.0049	A	P	3.273	kW	Q	0.004	kvar	S	3.273	kVA	<p>Max demand</p> <p>I1=4.9895A I2=4.9815A I3=5.0049A P=3.273kW Q=-0.024kvar S=3.273kVA</p>
I1	4.9895	A																		
I2	4.9815	A																		
I3	5.0049	A																		
P	3.273	kW																		
Q	0.004	kvar																		
S	3.273	kVA																		

4.2.2.5 module

No.	Display	Description
-----	---------	-------------

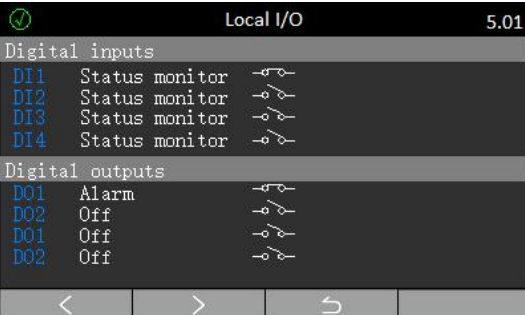
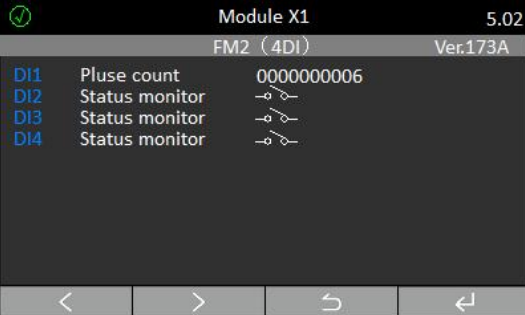
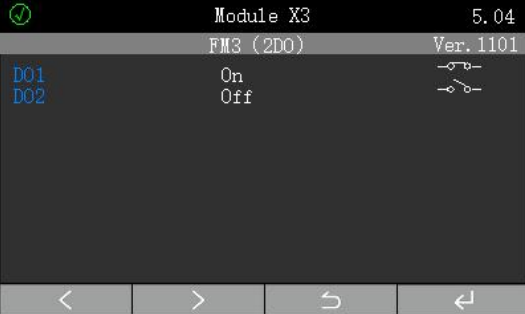
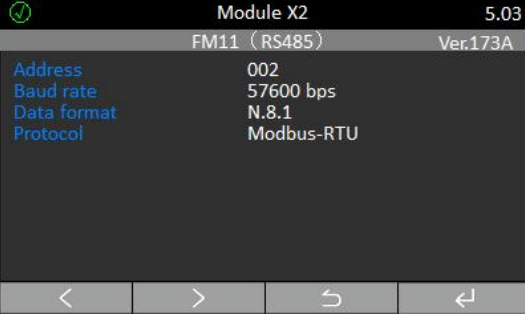
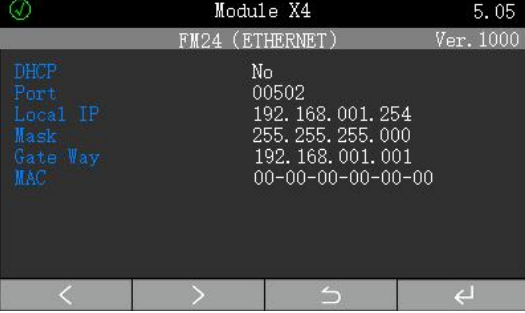
1	 <p>Local I/O 5.01</p> <p>Digital inputs</p> <p>DI1 Status monitor <input type="checkbox"/></p> <p>DI2 Status monitor <input type="checkbox"/></p> <p>DI3 Status monitor <input type="checkbox"/></p> <p>DI4 Status monitor <input type="checkbox"/></p> <p>Digital outputs</p> <p>DO1 Alarm <input type="checkbox"/></p> <p>DO2 Off <input type="checkbox"/></p> <p>DO1 Off <input type="checkbox"/></p> <p>DO2 Off <input type="checkbox"/></p>	Local I/O
2	 <p>Module X1 5.02</p> <p>FM2 (4DI) Ver.173A</p> <p>DI1 Pulse count 0000000006</p> <p>DI2 Status monitor <input type="checkbox"/></p> <p>DI3 Status monitor <input type="checkbox"/></p> <p>DI4 Status monitor <input type="checkbox"/></p>	Expand module FM2
3	 <p>Module X3 5.04</p> <p>FM3 (2DO) Ver.1101</p> <p>DO1 On <input type="checkbox"/></p> <p>DO2 Off <input type="checkbox"/></p>	Expand module FM3
4	 <p>Module X2 5.03</p> <p>FM11 (RS485) Ver.173A</p> <p>Address 002</p> <p>Baud rate 57600 bps</p> <p>Data format N.8.1</p> <p>Protocol Modbus-RTU</p>	Expand module2 FM11
5	 <p>Module X4 5.05</p> <p>FM24 (ETHERNET) Ver.1000</p> <p>DHCP No</p> <p>Port 00502</p> <p>Local IP 192.168.001.254</p> <p>Mask 255.255.255.000</p> <p>Gate Way 192.168.001.001</p> <p>MAC 00-00-00-00-00-00</p>	Expand module FM24

4.2.2.6 SOE logs

No.	Display	Description
-----	---------	-------------

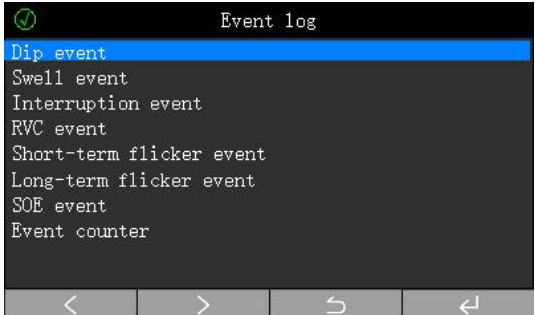
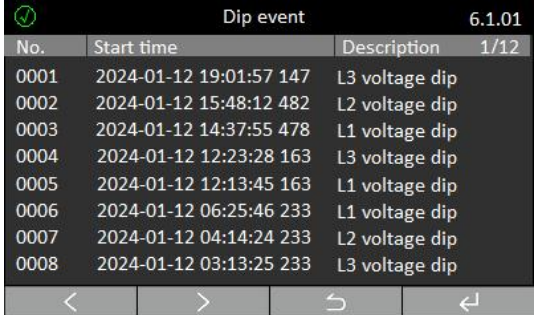
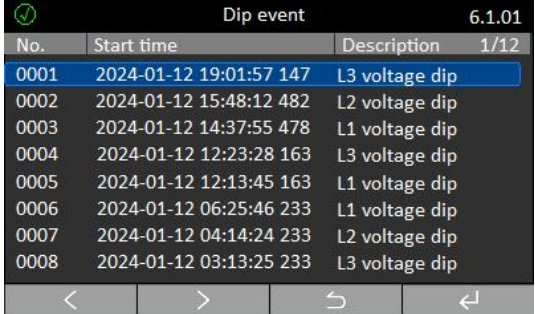
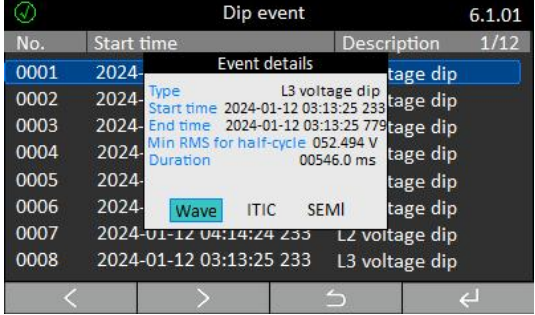
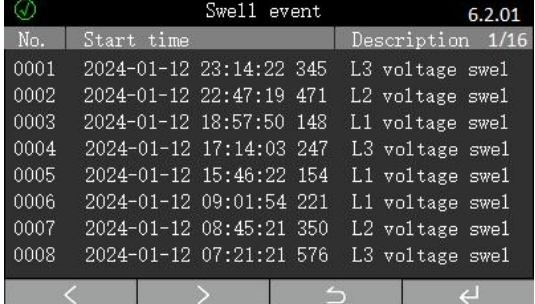
1	 <p>Event log</p> <ul style="list-style-type: none"> Dip event Swell event Interruption event RVC event Short-term flicker event Long-term flicker event SOE event Event counter 	SOE logs overview																											
2	 <table border="1"> <thead> <tr> <th>No.</th> <th>Start time</th> <th>Description</th> </tr> </thead> <tbody> <tr><td>0001</td><td>2024-01-12 19:01:57</td><td>L3 voltage dip</td></tr> <tr><td>0002</td><td>2024-01-12 15:48:12</td><td>L2 voltage dip</td></tr> <tr><td>0003</td><td>2024-01-12 14:37:55</td><td>L1 voltage dip</td></tr> <tr><td>0004</td><td>2024-01-12 12:23:28</td><td>L3 voltage dip</td></tr> <tr><td>0005</td><td>2024-01-12 12:13:45</td><td>L1 voltage dip</td></tr> <tr><td>0006</td><td>2024-01-12 06:25:46</td><td>L1 voltage dip</td></tr> <tr><td>0007</td><td>2024-01-12 04:14:24</td><td>L2 voltage dip</td></tr> <tr><td>0008</td><td>2024-01-12 03:13:25</td><td>L3 voltage dip</td></tr> </tbody> </table>	No.	Start time	Description	0001	2024-01-12 19:01:57	L3 voltage dip	0002	2024-01-12 15:48:12	L2 voltage dip	0003	2024-01-12 14:37:55	L1 voltage dip	0004	2024-01-12 12:23:28	L3 voltage dip	0005	2024-01-12 12:13:45	L1 voltage dip	0006	2024-01-12 06:25:46	L1 voltage dip	0007	2024-01-12 04:14:24	L2 voltage dip	0008	2024-01-12 03:13:25	L3 voltage dip	Dip event logs
No.	Start time	Description																											
0001	2024-01-12 19:01:57	L3 voltage dip																											
0002	2024-01-12 15:48:12	L2 voltage dip																											
0003	2024-01-12 14:37:55	L1 voltage dip																											
0004	2024-01-12 12:23:28	L3 voltage dip																											
0005	2024-01-12 12:13:45	L1 voltage dip																											
0006	2024-01-12 06:25:46	L1 voltage dip																											
0007	2024-01-12 04:14:24	L2 voltage dip																											
0008	2024-01-12 03:13:25	L3 voltage dip																											
3	 <table border="1"> <thead> <tr> <th>No.</th> <th>Start time</th> <th>Description</th> </tr> </thead> <tbody> <tr><td>0001</td><td>2024-01-12 19:01:57</td><td>L3 voltage dip</td></tr> <tr><td>0002</td><td>2024-01-12 15:48:12</td><td>L2 voltage dip</td></tr> <tr><td>0003</td><td>2024-01-12 14:37:55</td><td>L1 voltage dip</td></tr> <tr><td>0004</td><td>2024-01-12 12:23:28</td><td>L3 voltage dip</td></tr> <tr><td>0005</td><td>2024-01-12 12:13:45</td><td>L1 voltage dip</td></tr> <tr><td>0006</td><td>2024-01-12 06:25:46</td><td>L1 voltage dip</td></tr> <tr><td>0007</td><td>2024-01-12 04:14:24</td><td>L2 voltage dip</td></tr> <tr><td>0008</td><td>2024-01-12 03:13:25</td><td>L3 voltage dip</td></tr> </tbody> </table>	No.	Start time	Description	0001	2024-01-12 19:01:57	L3 voltage dip	0002	2024-01-12 15:48:12	L2 voltage dip	0003	2024-01-12 14:37:55	L1 voltage dip	0004	2024-01-12 12:23:28	L3 voltage dip	0005	2024-01-12 12:13:45	L1 voltage dip	0006	2024-01-12 06:25:46	L1 voltage dip	0007	2024-01-12 04:14:24	L2 voltage dip	0008	2024-01-12 03:13:25	L3 voltage dip	Dip event logs
No.	Start time	Description																											
0001	2024-01-12 19:01:57	L3 voltage dip																											
0002	2024-01-12 15:48:12	L2 voltage dip																											
0003	2024-01-12 14:37:55	L1 voltage dip																											
0004	2024-01-12 12:23:28	L3 voltage dip																											
0005	2024-01-12 12:13:45	L1 voltage dip																											
0006	2024-01-12 06:25:46	L1 voltage dip																											
0007	2024-01-12 04:14:24	L2 voltage dip																											
0008	2024-01-12 03:13:25	L3 voltage dip																											
4	 <table border="1"> <thead> <tr> <th>No.</th> <th>Start time</th> <th>Description</th> </tr> </thead> <tbody> <tr><td>0001</td><td>2024-01-12 03:13:25</td><td>L3 voltage dip</td></tr> <tr><td>0002</td><td>2024-01-12 03:13:25</td><td>L3 voltage dip</td></tr> <tr><td>0003</td><td>2024-01-12 03:13:25</td><td>L3 voltage dip</td></tr> <tr><td>0004</td><td>2024-01-12 03:13:25</td><td>L3 voltage dip</td></tr> <tr><td>0005</td><td>2024-01-12 03:13:25</td><td>L3 voltage dip</td></tr> <tr><td>0006</td><td>2024-01-12 03:13:25</td><td>L3 voltage dip</td></tr> <tr><td>0007</td><td>2024-01-12 04:14:24</td><td>L2 voltage dip</td></tr> <tr><td>0008</td><td>2024-01-12 03:13:25</td><td>L3 voltage dip</td></tr> </tbody> </table> <p>Event details for 0001:</p> <ul style="list-style-type: none"> Type: L3 voltage dip Start time: 2024-01-12 03:13:25 End time: 2024-01-12 03:13:25 Min RMS for half-cycle: 052.494 V Duration: 00546.0 ms Waveform: ITIC SEMI 	No.	Start time	Description	0001	2024-01-12 03:13:25	L3 voltage dip	0002	2024-01-12 03:13:25	L3 voltage dip	0003	2024-01-12 03:13:25	L3 voltage dip	0004	2024-01-12 03:13:25	L3 voltage dip	0005	2024-01-12 03:13:25	L3 voltage dip	0006	2024-01-12 03:13:25	L3 voltage dip	0007	2024-01-12 04:14:24	L2 voltage dip	0008	2024-01-12 03:13:25	L3 voltage dip	Dip event logs
No.	Start time	Description																											
0001	2024-01-12 03:13:25	L3 voltage dip																											
0002	2024-01-12 03:13:25	L3 voltage dip																											
0003	2024-01-12 03:13:25	L3 voltage dip																											
0004	2024-01-12 03:13:25	L3 voltage dip																											
0005	2024-01-12 03:13:25	L3 voltage dip																											
0006	2024-01-12 03:13:25	L3 voltage dip																											
0007	2024-01-12 04:14:24	L2 voltage dip																											
0008	2024-01-12 03:13:25	L3 voltage dip																											
5	 <table border="1"> <thead> <tr> <th>No.</th> <th>Start time</th> <th>Description</th> </tr> </thead> <tbody> <tr><td>0001</td><td>2024-01-12 23:14:22</td><td>L3 voltage swel</td></tr> <tr><td>0002</td><td>2024-01-12 22:47:19</td><td>L2 voltage swel</td></tr> <tr><td>0003</td><td>2024-01-12 18:57:50</td><td>L1 voltage swel</td></tr> <tr><td>0004</td><td>2024-01-12 17:14:03</td><td>L3 voltage swel</td></tr> <tr><td>0005</td><td>2024-01-12 15:46:22</td><td>L1 voltage swel</td></tr> <tr><td>0006</td><td>2024-01-12 09:01:54</td><td>L1 voltage swel</td></tr> <tr><td>0007</td><td>2024-01-12 08:45:21</td><td>L2 voltage swel</td></tr> <tr><td>0008</td><td>2024-01-12 07:21:21</td><td>L3 voltage swel</td></tr> </tbody> </table>	No.	Start time	Description	0001	2024-01-12 23:14:22	L3 voltage swel	0002	2024-01-12 22:47:19	L2 voltage swel	0003	2024-01-12 18:57:50	L1 voltage swel	0004	2024-01-12 17:14:03	L3 voltage swel	0005	2024-01-12 15:46:22	L1 voltage swel	0006	2024-01-12 09:01:54	L1 voltage swel	0007	2024-01-12 08:45:21	L2 voltage swel	0008	2024-01-12 07:21:21	L3 voltage swel	Swell event logs
No.	Start time	Description																											
0001	2024-01-12 23:14:22	L3 voltage swel																											
0002	2024-01-12 22:47:19	L2 voltage swel																											
0003	2024-01-12 18:57:50	L1 voltage swel																											
0004	2024-01-12 17:14:03	L3 voltage swel																											
0005	2024-01-12 15:46:22	L1 voltage swel																											
0006	2024-01-12 09:01:54	L1 voltage swel																											
0007	2024-01-12 08:45:21	L2 voltage swel																											
0008	2024-01-12 07:21:21	L3 voltage swel																											

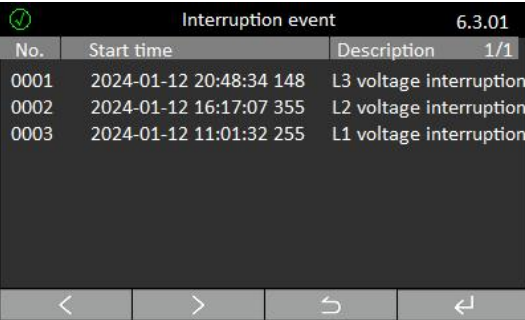
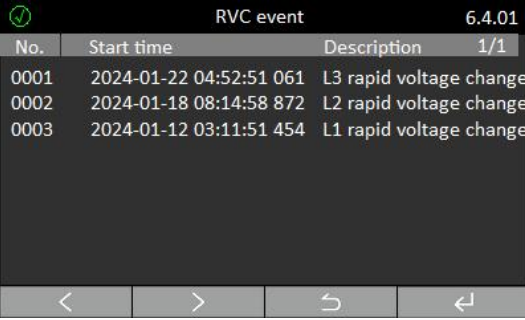
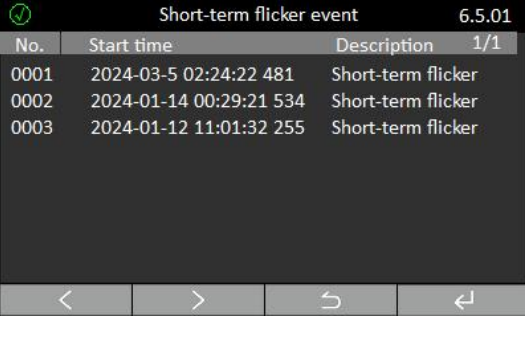
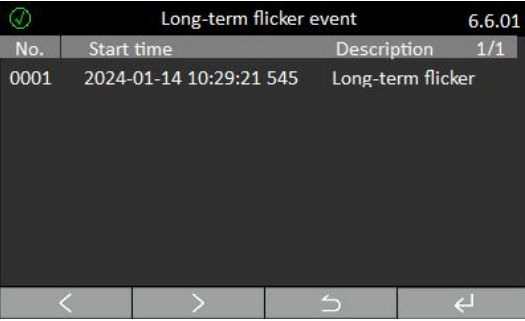
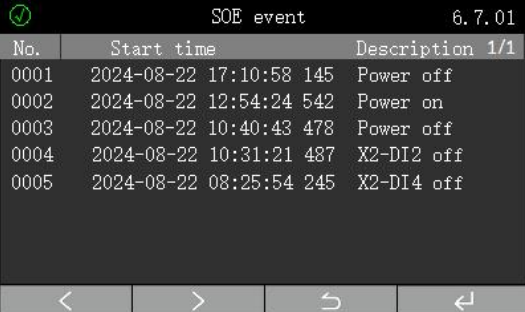
6	 <p>Interruption event 6.3.01</p> <table border="1"> <thead> <tr> <th>No.</th> <th>Start time</th> <th>Description</th> <th>1/1</th> </tr> </thead> <tbody> <tr> <td>0001</td> <td>2024-01-12 20:48:34 148</td> <td>L3 voltage interruption</td> <td></td> </tr> <tr> <td>0002</td> <td>2024-01-12 16:17:07 355</td> <td>L2 voltage interruption</td> <td></td> </tr> <tr> <td>0003</td> <td>2024-01-12 11:01:32 255</td> <td>L1 voltage interruption</td> <td></td> </tr> </tbody> </table>	No.	Start time	Description	1/1	0001	2024-01-12 20:48:34 148	L3 voltage interruption		0002	2024-01-12 16:17:07 355	L2 voltage interruption		0003	2024-01-12 11:01:32 255	L1 voltage interruption		Interruption event logs								
No.	Start time	Description	1/1																							
0001	2024-01-12 20:48:34 148	L3 voltage interruption																								
0002	2024-01-12 16:17:07 355	L2 voltage interruption																								
0003	2024-01-12 11:01:32 255	L1 voltage interruption																								
7	 <p>RVC event 6.4.01</p> <table border="1"> <thead> <tr> <th>No.</th> <th>Start time</th> <th>Description</th> <th>1/1</th> </tr> </thead> <tbody> <tr> <td>0001</td> <td>2024-01-22 04:52:51 061</td> <td>L3 rapid voltage change</td> <td></td> </tr> <tr> <td>0002</td> <td>2024-01-18 08:14:58 872</td> <td>L2 rapid voltage change</td> <td></td> </tr> <tr> <td>0003</td> <td>2024-01-12 03:11:51 454</td> <td>L1 rapid voltage change</td> <td></td> </tr> </tbody> </table>	No.	Start time	Description	1/1	0001	2024-01-22 04:52:51 061	L3 rapid voltage change		0002	2024-01-18 08:14:58 872	L2 rapid voltage change		0003	2024-01-12 03:11:51 454	L1 rapid voltage change		RVC event logs								
No.	Start time	Description	1/1																							
0001	2024-01-22 04:52:51 061	L3 rapid voltage change																								
0002	2024-01-18 08:14:58 872	L2 rapid voltage change																								
0003	2024-01-12 03:11:51 454	L1 rapid voltage change																								
8	 <p>Short-term flicker event 6.5.01</p> <table border="1"> <thead> <tr> <th>No.</th> <th>Start time</th> <th>Description</th> <th>1/1</th> </tr> </thead> <tbody> <tr> <td>0001</td> <td>2024-03-5 02:24:22 481</td> <td>Short-term flicker</td> <td></td> </tr> <tr> <td>0002</td> <td>2024-01-14 00:29:21 534</td> <td>Short-term flicker</td> <td></td> </tr> <tr> <td>0003</td> <td>2024-01-12 11:01:32 255</td> <td>Short-term flicker</td> <td></td> </tr> </tbody> </table>	No.	Start time	Description	1/1	0001	2024-03-5 02:24:22 481	Short-term flicker		0002	2024-01-14 00:29:21 534	Short-term flicker		0003	2024-01-12 11:01:32 255	Short-term flicker		Short term flick event logs								
No.	Start time	Description	1/1																							
0001	2024-03-5 02:24:22 481	Short-term flicker																								
0002	2024-01-14 00:29:21 534	Short-term flicker																								
0003	2024-01-12 11:01:32 255	Short-term flicker																								
9	 <p>Long-term flicker event 6.6.01</p> <table border="1"> <thead> <tr> <th>No.</th> <th>Start time</th> <th>Description</th> <th>1/1</th> </tr> </thead> <tbody> <tr> <td>0001</td> <td>2024-01-14 10:29:21 545</td> <td>Long-term flicker</td> <td></td> </tr> </tbody> </table>	No.	Start time	Description	1/1	0001	2024-01-14 10:29:21 545	Long-term flicker		Long term flick event logs																
No.	Start time	Description	1/1																							
0001	2024-01-14 10:29:21 545	Long-term flicker																								
10	 <p>SOE event 6.7.01</p> <table border="1"> <thead> <tr> <th>No.</th> <th>Start time</th> <th>Description</th> <th>1/1</th> </tr> </thead> <tbody> <tr> <td>0001</td> <td>2024-08-22 17:10:58 145</td> <td>Power off</td> <td></td> </tr> <tr> <td>0002</td> <td>2024-08-22 12:54:24 542</td> <td>Power on</td> <td></td> </tr> <tr> <td>0003</td> <td>2024-08-22 10:40:43 478</td> <td>Power off</td> <td></td> </tr> <tr> <td>0004</td> <td>2024-08-22 10:31:21 487</td> <td>X2-DI2 off</td> <td></td> </tr> <tr> <td>0005</td> <td>2024-08-22 08:25:54 245</td> <td>X2-DI4 off</td> <td></td> </tr> </tbody> </table>	No.	Start time	Description	1/1	0001	2024-08-22 17:10:58 145	Power off		0002	2024-08-22 12:54:24 542	Power on		0003	2024-08-22 10:40:43 478	Power off		0004	2024-08-22 10:31:21 487	X2-DI2 off		0005	2024-08-22 08:25:54 245	X2-DI4 off		SOE logs
No.	Start time	Description	1/1																							
0001	2024-08-22 17:10:58 145	Power off																								
0002	2024-08-22 12:54:24 542	Power on																								
0003	2024-08-22 10:40:43 478	Power off																								
0004	2024-08-22 10:31:21 487	X2-DI2 off																								
0005	2024-08-22 08:25:54 245	X2-DI4 off																								

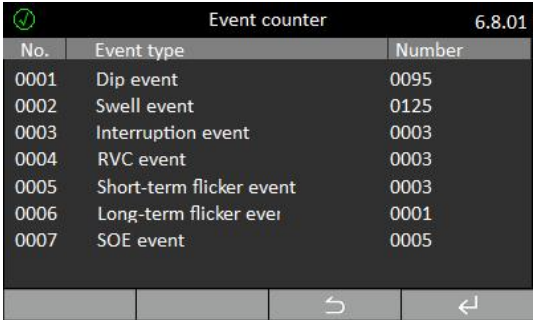
11	 <p>Event counter 6.8.01</p> <table border="1"> <thead> <tr> <th>No.</th> <th>Event type</th> <th>Number</th> </tr> </thead> <tbody> <tr> <td>0001</td> <td>Dip event</td> <td>0095</td> </tr> <tr> <td>0002</td> <td>Swell event</td> <td>0125</td> </tr> <tr> <td>0003</td> <td>Interruption event</td> <td>0003</td> </tr> <tr> <td>0004</td> <td>RVC event</td> <td>0003</td> </tr> <tr> <td>0005</td> <td>Short-term flicker event</td> <td>0003</td> </tr> <tr> <td>0006</td> <td>Long-term flicker ever</td> <td>0001</td> </tr> <tr> <td>0007</td> <td>SOE event</td> <td>0005</td> </tr> </tbody> </table>	No.	Event type	Number	0001	Dip event	0095	0002	Swell event	0125	0003	Interruption event	0003	0004	RVC event	0003	0005	Short-term flicker event	0003	0006	Long-term flicker ever	0001	0007	SOE event	0005	Event counter
	No.	Event type	Number																							
	0001	Dip event	0095																							
	0002	Swell event	0125																							
	0003	Interruption event	0003																							
	0004	RVC event	0003																							
	0005	Short-term flicker event	0003																							
	0006	Long-term flicker ever	0001																							
0007	SOE event	0005																								

4.2.2.7 Hlep

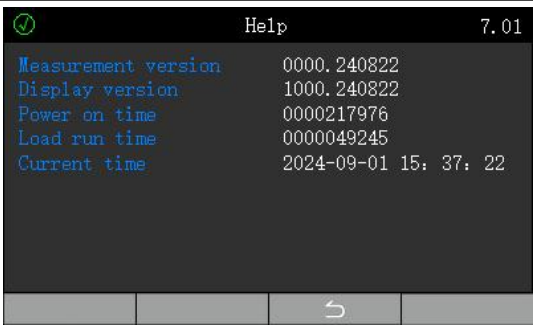
No.	Display	界面说明 Description
1	 <p>Help 7.01</p> <pre> Measurement version 0000.240822 Display version 1000.240822 Power on time 0000217976 Load run time 0000049245 Current time 2024-09-01 15: 37: 22 </pre>	help

4.3 Setup

4.3.1 Setup Menu

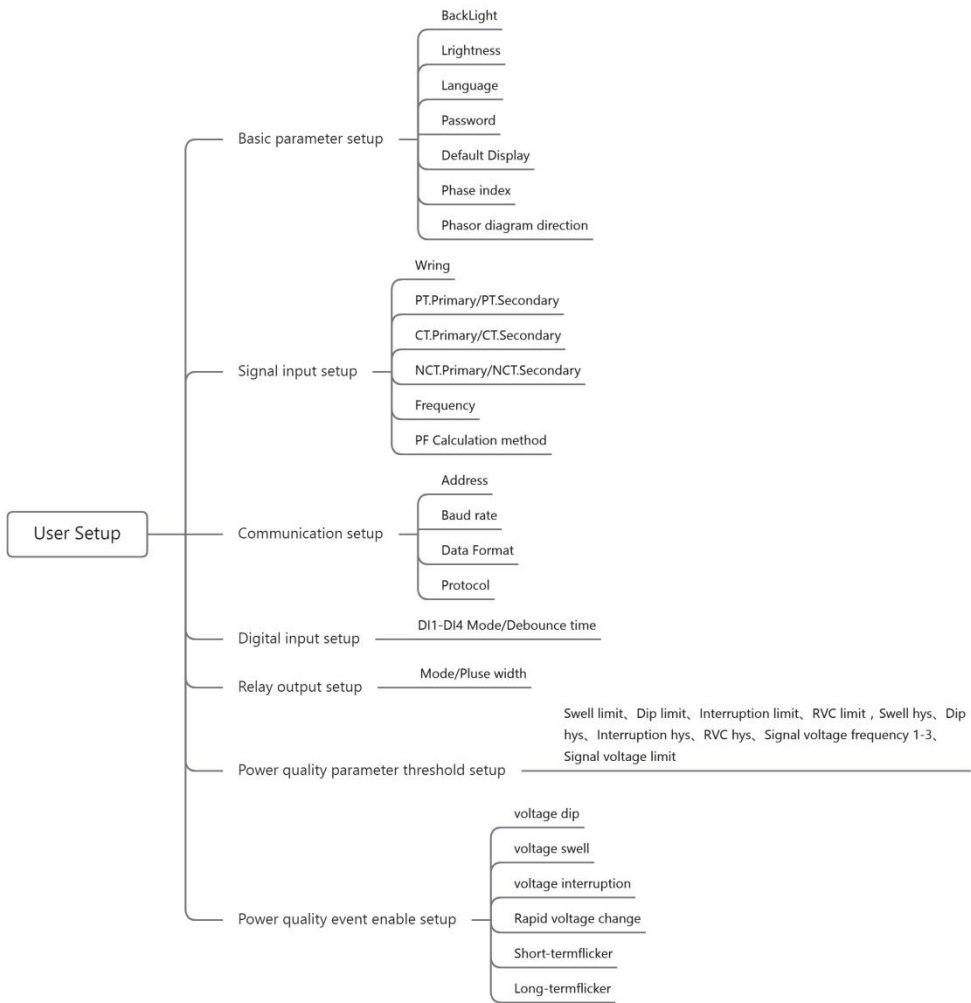

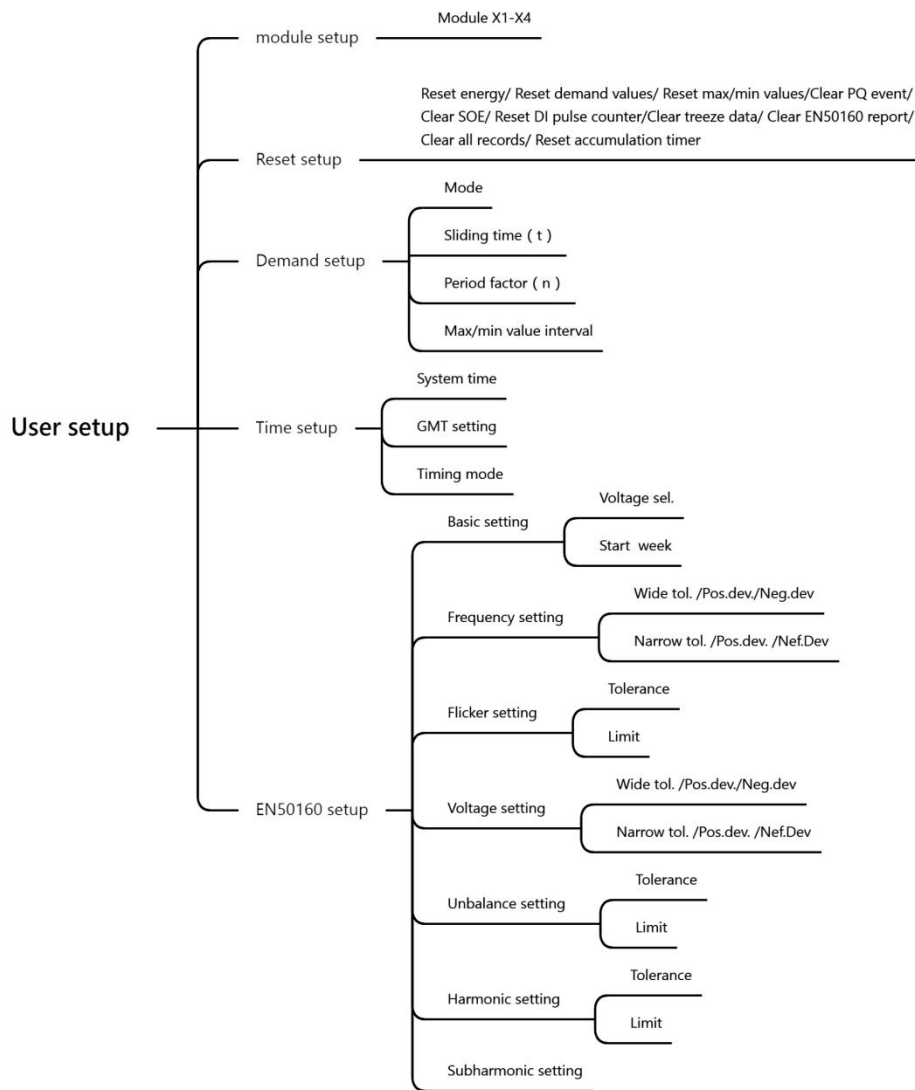

Figure 4.3.1.1 Overview of Setup Menu

4.3.2 Basic Parameter Setup

Display	Menu1	Menu2
	BackLight	01... 99min 00 - always on
	Brightness	Level 1...Level5
	Language	English
	Password	0000...9999
	Default interface	Main menu Instant overview Voltage Current Active power Reactive power Apparent power Power factor frequency

		Energy overview L1/L2/L3 energy Fundamental energy Tariff energy Present monthly energy THD Harmonic content Harmonic ratio Inter-harmonic content Inter-harmonic ratio Deviation Unbalance Phasor diagram Flicker Voltage Waveform Current Waveform Present demand Last demand Predicted demand Max demand Max demand of present month Digital I/O Module X1...X4 About
	Phase index	a.b.c
	Phasor diagram direction	Clock wise/Anti-clock wise

4.3.3 Signal Input Setup

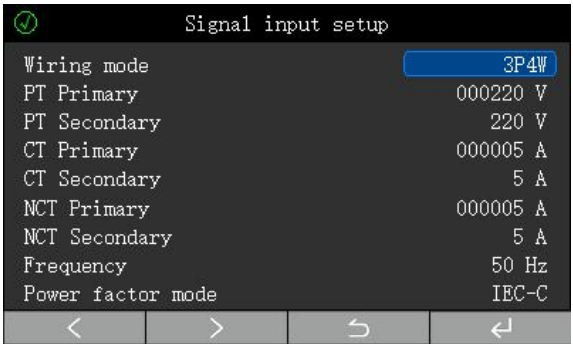
Display	Menu1	Menu2
 <p>Signal input setup</p> <p>Wiring mode 3P4W</p> <p>PT Primary 000220 V</p> <p>PT Secondary 220 V</p> <p>CT Primary 000005 A</p> <p>CT Secondary 5 A</p> <p>NCT Primary 000005 A</p> <p>NCT Secondary 5 A</p> <p>Frequency 50 Hz</p> <p>Power factor mode IEC-C</p>	Wiring mode	3P3W/3P4W
	PT Primary	1...999999V
	PT Secondary	1...600V
	CT Primary	1...999999A
	CT Secondary	1...6A
	NCT Primary	1...999999A
	NCT Secondary	1...6A
	Frequency	50Hz/60Hz
	Power factor mode	IEC-C/IEEE-C/IEC-P

4.3.4 Communication Setup

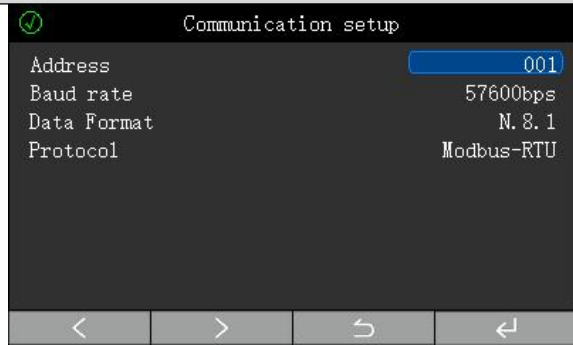
Display	Menu1	Menu2
 <p>Communication setup</p> <p>Address 001</p> <p>Baud rate 57600bps</p> <p>Data Format N. 8. 1</p> <p>Protocol Modbus-RTU</p>	Slave Address	1...247
	Baud rate	2400bps...115200bps
	Data format	E81,O81,N81,N82
	Protocol	Modbus-RTU

4.3.5 Digital Input Setup

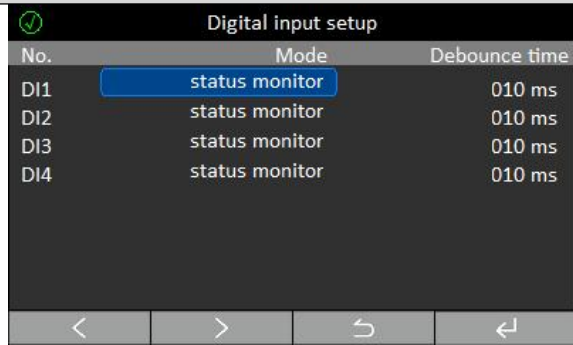
Display	Menu1	Menu2															
 <p>Digital input setup</p> <table border="1"> <thead> <tr> <th>No.</th> <th>Mode</th> <th>Debounce time</th> </tr> </thead> <tbody> <tr> <td>D11</td> <td>status monitor</td> <td>010 ms</td> </tr> <tr> <td>D12</td> <td>status monitor</td> <td>010 ms</td> </tr> <tr> <td>D13</td> <td>status monitor</td> <td>010 ms</td> </tr> <tr> <td>D14</td> <td>status monitor</td> <td>010 ms</td> </tr> </tbody> </table>	No.	Mode	Debounce time	D11	status monitor	010 ms	D12	status monitor	010 ms	D13	status monitor	010 ms	D14	status monitor	010 ms	Mode	Status monitor/ Pulse counting
No.	Mode	Debounce time															
D11	status monitor	010 ms															
D12	status monitor	010 ms															
D13	status monitor	010 ms															
D14	status monitor	010 ms															
	Debounce time	10...1000ms															

4.3.6 Relay Output Setup

Display	Menu1	Menu2
	Mode	Off/On/Alarm
	Pulse width	0.1...999.9s

4.3.7 Power quality threshold setup

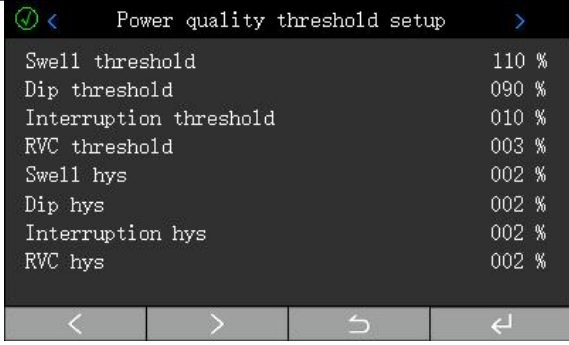
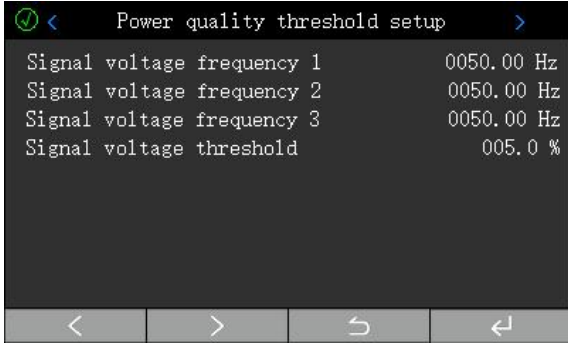
Display	Menu1	Menu2
	Swell threshold	100...180%
	Dip threshold	0...-100%
	Interruption threshold	0...100%
	RVC threshold	1...6%
	Swell hysteresis	0...10%
	Dip hysteresis	0...10%
	Interruption hysteresis	0...10%
	RVC hysteresis	0...3%
	Mains signaling voltage frequency	50.0...2575.0Hz
	Main signaling voltage threshold	0.3...100%

4.3.8 Power quality event setup

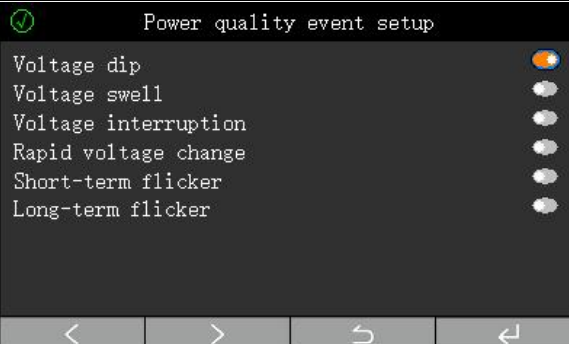
Display	Menu1	Menu2
	Swell	Enable/Disable
	Dip	Enable/Disable
	Interrupt	Enable/Disable
	RVC	Enable/Disable
	Short term flick	Enable/Disable
	Long term flick	Enable/Disable

4.3.9 Module setup

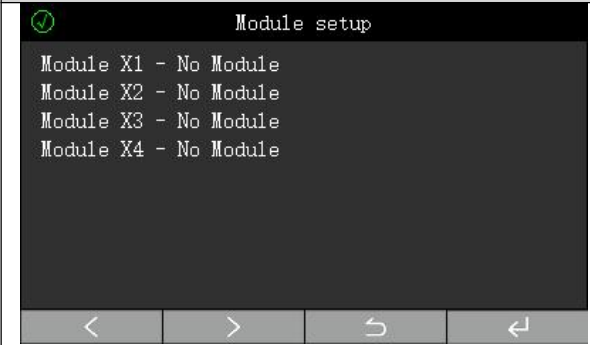
Display	Menu1
	Module setup

4.3.10 Reset setup

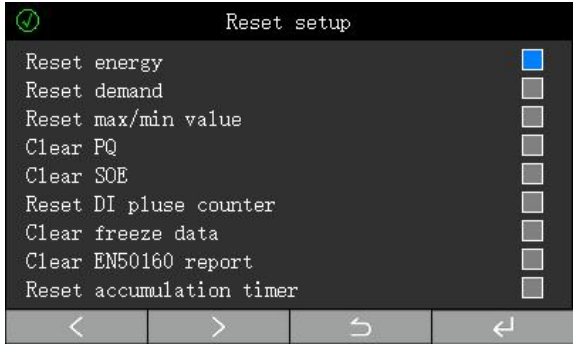
Display	Menu1	Menu2
	Reset energy values	Enable/Disable
	Reset demand values	Enable/Disable
	Reset max/min values	Enable/Disable
	Clear PQ event logs	Enable/Disable
	Clear SOE logs	Enable/Disable
	Reset DI pulse counter	Enable/Disable
	Clear freeze data	Enable/Disable
	Clear EN50160 report	Enable/Disable
	Reset accumulation timer	Enable/Disable

4.3.11 Demand setup

Display	Menu1	Menu2
	Mode	Sliding block/Fixed block
	Sliding time	1min...60 min
	Period factor	1t...30 t
	Max/min interval	Historical /1/5/15/30/60/1440 min

4.3.12 Time setup

Display	Menu1	Menu2
	System time	Year/Month/day/hour/minute/second
	Time zone	GMT-12:00 ...GMT+13
	Timing mode	Modbus/IRIG-B/Web/NTP

4.3.13 EN50160 Setup

Display	Menu1	Menu2	Menu3
	Basic update	Template	LV/MV/HV
		Start week	Monday...Sunday
	Frequency setup	Wide/Narrow Tolerance	0...100%
		Wide/Narrow positive deviation	0...200%
		Wide/Narrow negative deviation	0...100%
	Flicker setup	Tolerance	0...100%
Limit		0...100	
	Voltage setup	Wide/Narrow Tolerance	0...100%
		Wide/Narrow positive deviation	0...200%
		Wide/Narrow negative deviation	0...100%

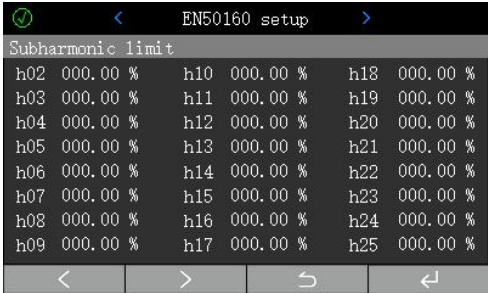
	Unbalance setup	Tolerance	0...100%
		Limit	0...100%
	Harmonics setup	Tolerance	0...100%
	THD limit setup	Limit	0...100%
		Harmonics limit	0...200%

5. Functions

5.1 Real-time measurements

The device can measure the full electric parameters of power grid.

measurement		Phase	Total	max	Min	Average	Demand
Voltage	Phase voltage	●	—	●	●	●	—
	Line voltage	●	—			●	—
	Fundamental voltage	●	—			—	—
Current	Current	●	—	●	●	●	●
	Neutral current	—	●	●	●	—	—
	Fundamental current	●	—			—	—
Power	Active power	●	●	●	●	●	●
	Reactive power	●	●	●	●	●	●
	Apparent power	●	●	●	●	●	●
Power factor		●	●	●	●	—	—
Frequency		—	●	●	●	—	—

5.2 Energy metering

The device can metering energies, which are specifically as follows:

- Bidirectional active energy/reactive energy
- Fundamental active energy/reactive energy

-
- Four-quadrant reactive energy
 - Apparent energy
 - Tariff energy

The energy values displayed by the device are all primary values, which are obtained by multiplying the secondary value by magnification ratios of voltage and current transformers. All electric energy values are based on secondary values. The minimum resolution for accumulation of secondary electric energy values is 1Wh or 1varh, and the minimum display resolution of electric energy values is 0.001kWh or 0.001kvarh. The maximum energy that can be retained is 4,294,967,295Wh on the secondary side. The display range of electric energy is initially 99,999,999,999kWh (99.9 Billion kWh). There will be no overflow during normal service life of the device. Users can manually reset and clear the electric energy data according to their own needs (user password is required).

The device provides 6 sets of daily tariffs that can be set, weekly tariffs or 12 time zone tariffs that are optional, and 90 variable holidays that can be set. When the switching time is reached or the year/month registers of switching time are directly written with 0xFFFF, the present rate setting will be directly overwritten by backup rate setting, and the switching time register will be cleared (the device will always run under the present rate setting).

The following tariff energy will be recorded:

- Present total/T1/T2/T3/T4/T5/T6/T7/T8 energy
- Total/T1/T2/T3/T4/T5/T6/T7/T8 energy for this month
- Historical total/T1/T2/T3/T4/T5/T6/T7/T8 energy for past 1 month to past 12 months.

5.3 Demand

The device can provide present period demand, previous period demand, maximum demand, maximum demand of present month, maximum demand of previous month and maximum demand of past 2 months, and two calculation methods, i.e., sliding block and fixed block, and the relevant setup can be made through communication.

The device can measure basic demand values, including 6 fixed demand values (I1, I2, I3, P, Q, S) and 10 optional demand values (see communication manual). The demand can be measured with 2 methods: sliding block and fixed block. The time parameter setup involved include t (sliding time, unit: minute) and T (sliding cycle/interval time, unit: minute).

Sliding block: Every t minutes, it calculates the average demand value in the most recent T minutes, makes judgments and records, and conducts automatic meter reading for the monthly demand.

Fixed block: Every T minutes, it calculates the average demand value in the most recent T minutes, makes judgments and records, and conducts automatic meter reading for the monthly demand.

5.3.1 Sliding Block Demand

The setup related to sliding calculation are as follows:

- ✧ Mode: Sliding Block.
- ✧ Sliding Time (t) : “1” minute.
- ✧ Period Factor (n) : Set to “15”.

The calculation method is shown in Figure 5.2.1.1:

- Previous period Demand = $(dmd_{t1} + dmd_{t2} + \dots + dmd_{t14} + dmd_{t15}) / 15$
- Present period Demand = $(dmd_{t2} + dmd_{t3} + \dots + dmd_{t15} + dmd_{t16}) / 15$

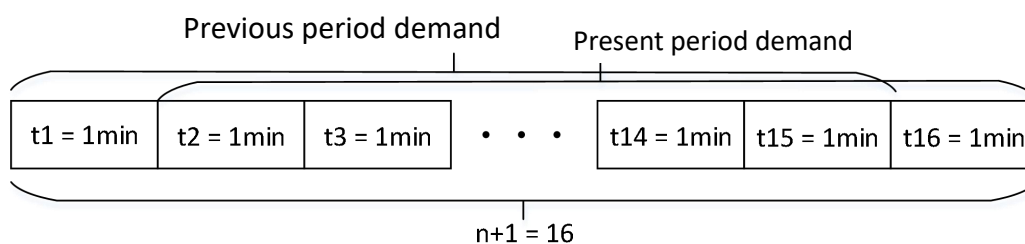

Figure 5.2.1.1 Sliding Demand Calculation

5.3.2 Fixed Block Demand

The setup related to fixed block calculation are as follows:

- ✧ Mode: Fixed block.
- ✧ Sliding Time (t) : “1” minute.
- ✧ Period Factor (n) : “15”.

The calculation method is shown in Figure 5.2.2.1:

- Previous period demand = $(dmd_{t1} + dmd_{t2} + \dots + dmd_{t14} + dmd_{t15})/15$
- Present period demand = $(dmd_{t16} + dmd_{t17} + \dots + dmd_{t29} + dmd_{t30})/15$

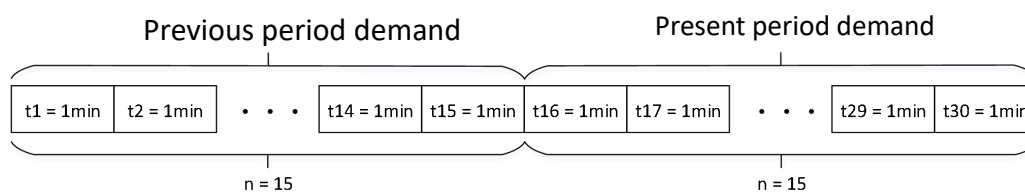

Figure 5.2.2.1 Fixed Block Demand Calculation

5.4 Max/Min Values

The device provides two types of max/min values i.e., interval values or historical values. When the interval time is set to “0”, it is the historical value; when it is not set to “0”, it is the interval value. When the interval time is set to 15min and the current time is 12:20, the values displayed by the device is the values within 12:00-12:15.

The device provides basic max/min data, including 15 fixed max data, 15 fixed min data and 34 programmed data.

5.5 Power Quality

5.5.1 Power Quality

The device can monitor and analyze the power quality of grid, including the following measurement parameters:

Voltage deviation, frequency deviation, harmonics, inter-harmonics, unbalance, flicker, swell, dip, interruption and voltage rapid change.

5.5.2 Fundamental Wave Analysis

the device can provide the following fundamental data:

- Split-phase fundamental phase/line voltage
- Split-phase fundamental current

- Split-phase/total fundamental active power
- Split-phase/total fundamental reactive power
- Split-phase/total fundamental apparent power
- Split-phase/total fundamental power factor

5.5.3 Crest Factor

The device calculates the crest factor by analyzing a complete voltage and current cycle to provide crest factors of three-phase voltage and current:

$$\text{Crest factor} = \text{Peak value} / \text{r.m.s value}$$

5.5.4 k-Factor

The device calculates the k-factor based on the calculated harmonic data of current to provide k-factor of three-phase current:

$$k = \frac{\sum_{h=2}^{h=h_{\max}} I_h^2 h^2}{I_{th}^2}$$

In which, h refers to the harmonic order, I_h refers to the value of harmonic distortion for the h^{th} current harmonic, and I_{th} refers to the value of total harmonic distortion. the device is capable of measuring 2nd - 51st harmonics. Therefore, h_{\max} is equal to 51.

5.5.5 Voltage Deviation

Changes in the running mode of power supply and distribution system and slow variations in load will cause the voltage at various points of the system to change accordingly. The difference between voltage at each point and rated voltage is known as voltage deviation, which is usually expressed as a percentage. The calculation method is as follows:

$$\Delta U = \frac{U - U_N}{U_N} \times 100\%$$

ΔU - voltage deviation

U - the actual voltage

U_N - the rated voltage.

5.5.6 Frequency Deviation

Frequency deviation refers to the difference between actual value and nominal value of system frequency under normal running conditions in the power system. The

calculation method is as follows:

$$\text{Frequency deviation} = \text{Actual frequency} - \text{Nominal frequency}$$

5.5.7 Harmonic and Inter-harmonic

Harmonics: Perform Fourier series decomposition on the periodic alternating quantity to obtain components with frequencies that are integer multiples of the fundamental frequency higher than 1;

Inter-harmonics: Perform Fourier series decomposition on the periodic alternating quantity to obtain components with frequencies that are not equal to integer multiples of the fundamental frequency higher than 1;

the device provides the following harmonic data:

- Split-phase 2nd ... 51st voltage/current harmonic ratio
- voltage/current THD
- voltage/current harmonics content
- Split-phase harmonic active power
- Split-phase harmonic reactive power
- Split-phase 2nd ... 51st inter-harmonic ratio of voltage/current
- Voltage/current inter-harmonics content

5.5.8 Unbalance

For 3-phase 4-wire system, the device calculates voltage and current unbalance according to the calculated positive and negative sequence components of voltage and current; for 3-phase 4-wire system, the device calculates voltage and current unbalance according to the calculated maximum and average voltage and current values.

For 3-phase 4-wire System:

$$\text{Unb2} = \frac{U_2}{U_1} \times 100$$

$$\text{Unb0} = \frac{U_0}{U_1} \times 100$$

$$\text{Inb2} = \frac{I_2}{I_1} \times 100$$

$$\text{Inb0} = \frac{I_0}{I_1} \times 100$$

For 3-phase 3-wire System:

$$Unb = \frac{\max(U - U_{avg})}{U_{avg}} \times 100$$

$$Inb = \frac{\max(I - I_{avg})}{I_{avg}} \times 100$$

The device simultaneously provides the real and imaginary parts of fundamental wave of voltage and current.

5.5.9 Voltage Flicker

The human visual response to unstable illumination caused by voltage fluctuations (lamp flickering) is known as flicker. In other words, flicker reflects the impact of lamp flickering caused by voltage fluctuations on human visual perception.

The device provides short-term and long-term flicker values along with time stamps. Specifically, the short-term flicker update cycle is 10min, while the long-term flicker update cycle is 2h.



Figure 4.2.2.3.8.1 Waveform Screenshot of Voltage Flicker

5.5.10 Voltage Swell, dip and Interruption

Voltage Swell: Under power-frequency conditions, the root-mean-square value of voltage rises to 1.1-1.8 times of rated voltage.

Voltage dip: Under power-frequency conditions, the root-mean-square value of voltage drops to 0.1...0.9 times of rated voltage.

Voltage Interruption: Under power-frequency conditions, the root-mean-square value of voltage drops below 0.1 times of rated voltage for not more than 1min.

The device provides the following functions:

- Split-phase voltage swell, dip and interruption events
- Occurrence and end time, duration and extreme values during voltage swell, dip and interruption events
- Waveform recordings of voltage swell, dip and interruption events

The device provides the following relevant parameter Setup:

- Event enable setting
- Selection and setting of data sources for event

- Setup for event threshold, hysteresis and determination of occurrence duration



Figure 4.2.2.3.9.1 Waveform Screenshot of Voltage Swell



Figure 4.2.2.3.9.2 Waveform Screenshot of Voltage dip

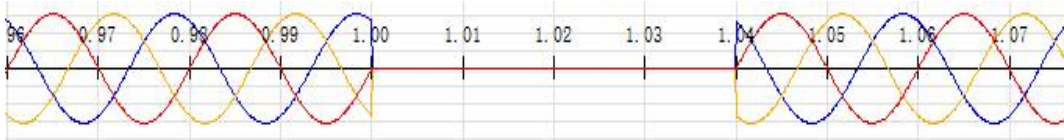

Figure 4.2.2.3.9.3 Waveform Screenshot of Voltage Interruption

5.5.11 Rapid Voltage Change

Rapid voltage change refers to a rapid transition in the effective value of voltage between two stable voltage states, with the maximum change in effective voltage value not exceeding the threshold for voltage swell or dip.

the device provides the following functions:

- Rapid change events of split-phase/total voltage
- Occurrence and end time, duration, ΔU_{max} and ΔU_{ss} of rapid voltage change event
- Waveform recordings during a rapid voltage change event

the device provides the following relevant parameter Setup:

- Event judgment enable setting
- Event judgment threshold and hysteresis setting

ΔU_{max} : It refers to the maximum absolute value of difference between the last U_{avg} before an RVC event starts and any U_{rms} during the event. For a multiphase system, it refers to maximum value among ΔU_{max} of all phases.

ΔU_{ss} : It refers to the absolute value of difference between the last U_{avg} before an event starts and the first U_{avg} after the event ends. For a multiphase system, the maximum value among all phases is taken.

U_{avg} : It refers to the arithmetic mean of 100 consecutive U_{rms} .

U_{rms} : It refers to the effective value of voltage half-wave.

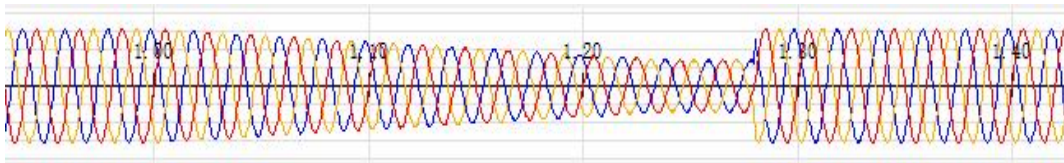

Figure 4.2.5 Waveform Screenshot of Rapid Voltage Change

5.6 Alarm

The device can provide independent alarms with enable, limit, hysteresis, and delay time. When an alarm is triggered, the register value of the alarm state of the communication address table will be updated accordingly.

The alarm item includes voltage, current, power, THD etc.

Triggering Conditions of Alarm:

- 1) The corresponding alarm is enabled.
- 2) The value is more than the threshold in case of upper limit alarms; the value is less than the threshold in case of lower limit alarms.
- 3) The duration exceeds the delay time

Release Conditions of Alarm:

The value is less than the threshold - hysteresis in case of upper limit alarms; the value is more than the value of threshold + hysteresis in case of lower limit alarms.

Alarm item:

LN-Voltage	N-phase Current
LL-Voltage	Total Active Power
Current	Total Reactive Power
Total Apparent Power	1 st ... 50 th current inter-harmonic ratio
Total Power Factor	1 st ... 50 th voltage inter-harmonic content
Zero-sequence voltage unbalance	1 st ... 50 th current inter-harmonic content

Negative-sequence voltage unbalance	DI1 ON
Zero-sequence current unbalance	DI1 OFF
Negative-sequence current unbalance	DI2 ON
Fundamental Voltage	DI2 OFF
Fundamental Current	DI3 ON
Voltage Deviation	DI3 OFF
Frequency	DI4 ON
Frequency Deviation	DI4 OFF
THD-V	X1-DI1 ON
TOHD-V	X1-DI1 OFF
TEHD-V	X1-DI2 ON
THD-I	X1-DI2 OFF
TOHD-I	X1-DI3 ON
TEHD-I	X1-DI3 OFF
TIHD-V	X1-DI4 ON
TOIHD-V	X1-DI4 OFF
TEIHD-V	X2-DI1 ON
TIHD-I	X2-DI1 OFF
TOIHD-I	X2-DI2 ON
TEIHD-I	X2-DI2 OFF
HC_V	X2-DI3 ON
HC_I	X2-DI3 OFF
IHC_V	X2-DI4 ON
IHC_I	X2-DI4 OFF
Present demand-P	X3-DI1 ON
Present demand-Q	X3-DI1 OFF
Present demand-S	X3-DI2 ON
Present demand-PF	X3-DI2 OFF
Forecast demand-P	X3-DI3 ON
Forecast demand-Q	X3-DI3 OFF
Forecast demand-S	X3-DI4 ON
Forecast demand-PF	X3-DI4 OFF
Short-term flicker	X4-DI1 ON
Long-term flicker	X4-DI1 OFF
Rapid voltage change	X4-DI2 ON
2 nd ... 51 st voltage harmonic ratio	X4-DI2 OFF
2 nd ... 51 st current harmonic ratio	X4-DI3 ON
2 nd ... 51 st voltage harmonic content	X4-DI3 OFF
2 nd ... 51 st current harmonic content	X4-DI4 ON
1 st ... 50 th voltage inter-harmonic ratio	X4-DI4 OFF

5.7 Event Log

The device provides 1,024 data records for querying, where each record can be divided into two parts i.e., event + occurrence time. The event is divided into a high byte (event classification) and a low byte (specific event), as shown in the following table:

High byte	Event Classification	Low byte	Specific Events
0x00	No event	—	—
0x01	Power on/off event	0x00	Power off
		0x01	Power on
0x02	Over-limit start event	—	see communication manual
0x03	Over-limit end event	—	
0x04	DI event	0x00	DI1 ON
		0x01	DI1 OFF
		0x02	DI2 ON
		0x03	DI2 OFF
		0x04	DI3 ON
		0x05	DI3 OFF
		0x06	DI4 ON
		0x07	DI4 OFF
		0x08	X1-DI1 ON
		0x09	X1-DI1 OFF
		0x0A	X1-DI2 ON
		0x0B	X1-DI2 OFF
		0x0C	X1-DI3 ON
		0x0D	X1-DI3 OFF
		0x0E	X1-DI4 ON
		0x0F	X1-DI4 OFF
		0x10	X2-DI1 ON
		0x11	X2-DI1 OFF
		0x12	X2-DI2 ON
		0x13	X2-DI2 OFF
		0x14	X2-DI3 ON
		0x15	X2-DI3 OFF
		0x16	X2-DI4 ON
		0x17	X2-DI4 OFF
		0x18	X3-DI1 ON
		0x19	X3-DI1 OFF
		0x1A	X3-DI2 ON
		0x1B	X3-DI2 OFF
		0x1C	X3-DI3 ON
		0x1D	X3-DI3 OFF
		0x1E	X3-DI4 ON
		0x1F	X3-DI4 OFF
0x20	X4-DI1 ON		
0x21	X4-DI1 OFF		
0x22	X4-DI2 ON		
0x23	X4-DI2 OFF		
0x24	X4-DI3 ON		
0x25	X4-DI3 OFF		
0x26	X4-DI4 ON		
0x27	X4-DI4 OFF		
0x05	DO event	0x00	DO1 ON
		0x01	DO1 OFF
		0x02	DO2 ON
		0x03	DO2 OFF
		0x04	DO3 ON

		0x05	DO3 OFF
		0x06	DO4 ON
		0x07	DO4 OFF
		0x08	X1- DO1 ON
		0x09	X1- DO1 OFF
		0x0A	X1- DO2 ON
		0x0B	X1- DO2 OFF
		0x0C	X2- DO1 ON
		0x0D	X2- DO1 OFF
		0x0E	X2- DO2 ON
		0x0F	X2- DO2 OFF
		0x10	X3- DO1 ON
		0x11	X3- DO1 OFF
		0x12	X3- DO2 ON
		0x13	X3- DO2 OFF
		0x14	X4- DO1 ON
		0x15	X4- DO1 OFF
		0x16	X4- DO2 ON
		0x17	X4- DO2 OFF
0x06	Meter operation event	0x00	Setup change
		0x01	Reset energy values
		0x02	Reset demand values
		0x03	Reset max/min values
		0x05	Clear SOE logs
		0x07	Reset DI pulse counter
		0x09	Reset running timer
		0x0A	Clear PQ event
		0x0B	Clear EN50160 report
		0x0C	Clear freeze data
		0xFF	Clear all records

5.8 Data Freezing

The device can freeze data, including 5 fixed data (import active energy, export active energy, import reactive energy, export reactive energy and apparent energy) and 20 optional data. Freeze interval can select 1min, 5min, 15min, 30min, 60min or 1440min.

5.9 Address Mapping

The device has 60 registers that its address can be programmed.

For example, if the host computer wants to read “phase voltage-V1”, “phase voltage-V2”, “phase voltage-V3”, and “average phase voltage” in one frame, you can set as follows:

- Custom data setting 1/2 set to “0x0006”/“0x0007” (address of phase voltage-V1)

-
- Custom data setting 3/4 set to “0x0008”/“0x0009” (address of phase voltage-V2)
 - Custom data setting 5/6 set to “0x000A”/“0x000B” (address of phase voltage-V3)
 - Custom data setting 7/8 set to “0x0310”/“0x0311” (Address of average phase voltage)

After the setting is completed, the host computer can read 8 addresses directly from the 0x1000 to complete a frame reading the above data.

5.10 Digital Input

The digital input module adopts the dry contact mode. Since it is equipped with an built-in power source, the device can be used to monitor the state of the circuit breaker, accumulate the pulses of energy without external power source.

5.11 Relay Output

Relay output can select three modes,including OFF mode,alarm mode and remote control mode.

5.12 Expand Module

- FM2: 4 digital inputs
- FM3: 2 relay outputs
- FM11: RS485, Modbus-RTU
- FM24: BACnet/IP communication

The device supports expand module,including FM2,FM3,FM11 and FM24.