

MOTOR PROTECTION CONTROLLER

www.sfere-elec.net

Electrical Application Solution Expert



COMPARISON TABLE



Model		WDH-31-200	WDH-31-580
Control Mode		-	9
Motor Protection		9	21
Measuring	Voltage	1-phase	3-phase
	Current	■	■
	Current unbalance	■	■
	Ground current(0.3-8.0In)	-	■
	Residual current(50-5000mA)	□	■
	Frequency	-	■
	Power, Power factor	-	■
	Energy	-	■
	Temperature	-	■
	Analog input(4-20mA)	-	-
Communication	Modbus-RTU	■	□
	Double Modbus-RTU	-	□
	Profibus-DP	-	□
Real-time Clock	RTC	-	■
Digital Inputs	Dry contact input	-	12
	Wet contact input	-	□
Relay Outputs	Control relays	1	4
	Signal relays	1	4
Analog Input	DC 4-20mA	-	-
Analog Output	DC 4-20mA	□	■
Records	Alarm and fault record	■	■
	Motor start and stop record	-	■
	Running and stopping time record	-	■

NOTE: "■": Yes "□": No "□": Optional

WDH-3 1-200



Modbus Interface
Protection (9 Types)
Analog Output



FUNCTION

Motor Protection

- Start timeout
- Stall
- Locked rotor
- Overload
- Under load
- Over voltage
- Low voltage
- Current unbalance
- Residual current

Measuring

- 1-phase voltage
- 3-phase current
- Residual current (optional)



APPLICATIONS



PRODUCT COMBINATION

- Controller
- CT: SHH
- Residual CT (optional)
- External CT (optional): SHI-ZT40, 5P10: 500A/5A, 800A/5A, corresponding controller rated current of 5A



MODELS

WDH-31-203K

Current Code	Optional Code	Installation Mode	Cable Length for CT
1A 50A	L: residual current	Y: Integrated	1m
2A 100A	M2: Analog output	F: Split	3m
6.3A 200A			
30A 5A(Secondary current)			

Current	Rated Current for Motor	SHI-I CT Code
1A	0.2A~1A	SHI01-I, ϕ 20mm
2A	1A~2A	
6.3A	2A~6.3A	SHI30-I, ϕ 20mm
30A	6.3A~30A	
50A	30A~50A	SHI200-I, ϕ 20mm
100A	50A~100A	
200A	100A~200A	SHI300-I, ϕ 30mm
5A	/	SHI30-I, ϕ 20mm

OPTIONAL CT



	THREE-PHASE CT	EXTERNAL CT	RESIDUAL CURRENT CT
Model	SHI01-I/SHI30-I/SHI200-I	SHI300-I	SHI-ZT40 SHI-ZT30 SHI-ZT100
Diameter(mm)	20	30	42×30 31 100
Dimension(mm)	93×45×96	185×36×72	75×44×102 75×44×98 185×44×190



DIMENSIONS

Split Installation (Cut-out Size: 94×46mm)

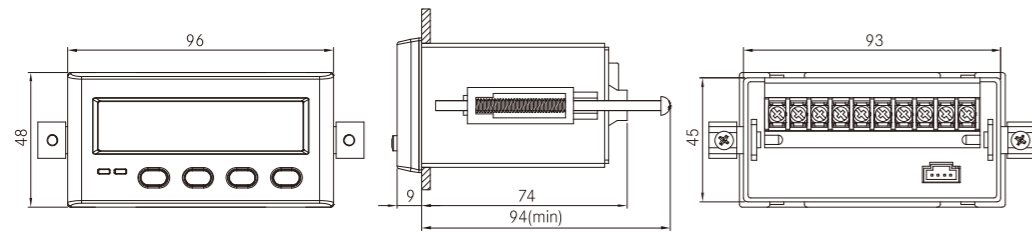

Integrated Installation

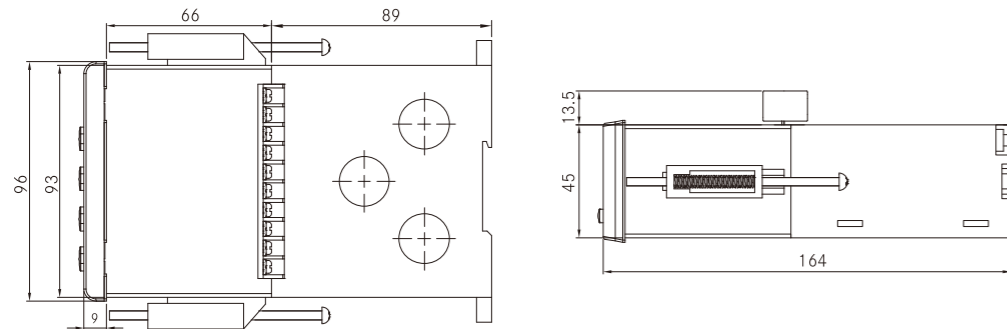

TECHNICAL SPECIFICATION

System	Rated voltage of motor	AC 380V or AC 660V, 50Hz
	Rated current of motor	0.1 A~800 A
	Insulation resistor	≥100MΩ
Safe Power Supply	Working range	AC 100~415V
	Power consumption	≤3VA
Environment Condition	Operating temperature	-20℃~+60℃
	Relative humidity	≤93%RH
	Storage temperature	-25℃~70℃
	IP degree	Front: IP64, Rear: IP20
Protection Accuracy	Current/ voltage	±1% of setting value
	Thermal capacity	±1% of setting value
	Delayed acting time	When delayed acting value < 2s: ±100ms When delayed acting value ≥2s: ±5%
Control Relay	Contact capacity	AC 250V/5A
Signal Relay	Contact capacity	AC 250V/5A
Analog Output	Mode	DC 4~20mA, RL≤350Ω
Insulation		≥2kVAC



TYPICAL WIRING

Wiring Diagram With Residual Current Function

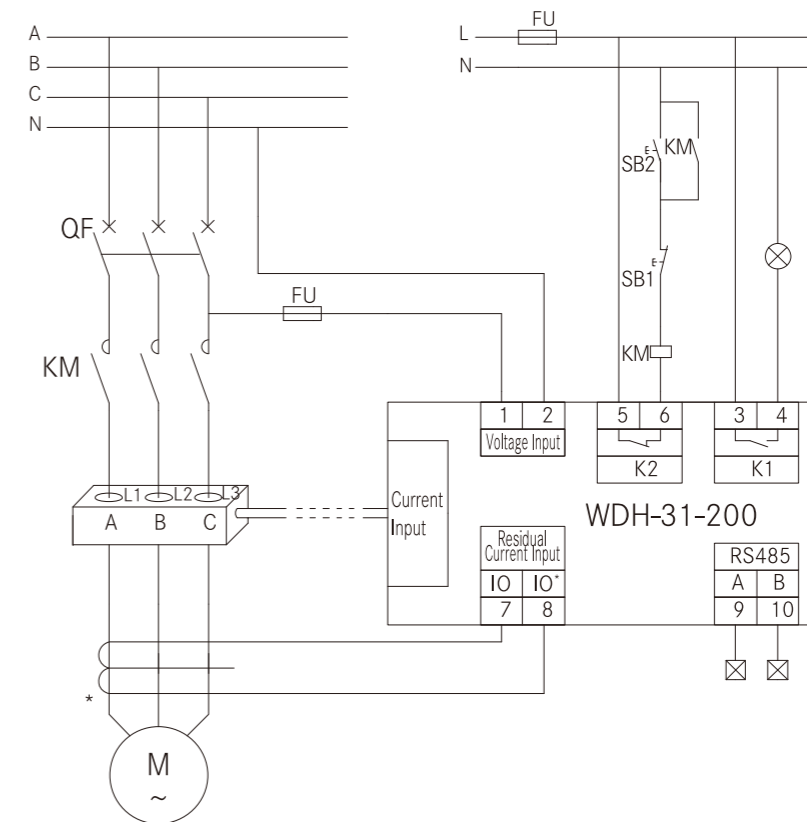

Wiring Diagram With Analog Output Function

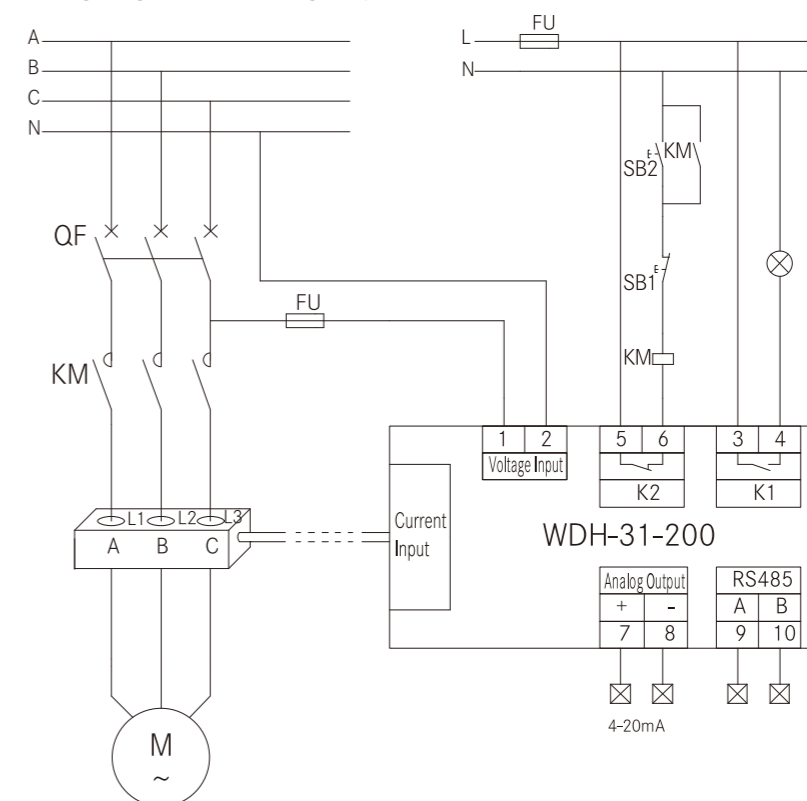

WDH-3 1-580



Modbus Interface
Protection (21 Types)
Analog Output
Temperature
Harmonics



FUNCTION

Motor Protection

- Start timeout
- Stall
- Locked rotor
- Overload
- Under load
- Current unbalance
- Over voltage
- Low voltage
- Residual current
- Phase loss
- Phase-sequence
- Under power
- Temperature
- Analog input
- External fault
- tE time

Measuring

- 3-phase voltage
- 3-phase current
- Residual current
- Energy
- Harmonics

Communication

- Profibus-DP
- Modbus-RTU
- Ethernet Modbus/TCP

APPLICATION

Buildings (Commercial building, school, hospital...)	Industrial Facilities (steel, petrochemical, electronic...)	Utilities (railway, airport, water supply...)
---------------------------------------------------------	----------------------------------------------------------------	--------------------------------------------------



MODELS

WDH-3-1-58 □ □ - □ □ □ / □ / □ □

Communication Protocol	Control Mode	Current Specification of Protection Controller	Main Circuit Voltage	Digital Input Type	Optional Functions	Additional Components
2: 1 Profibus-DP protocol+ 1 Modbus-RTU protocol	A: Direct start	1:5A	1:AC 380V	1: Internal DC24V power supply	R: Insulation resistance monitoring	D: Switching module-DC24V
3: 2 Modbus-RTU protocol	B: Bi-directional start	2:25A	2:AC 660V	2: External AC220V power supply	V: Anti voltage sag/under voltage restart	DA: Switching module-AC220v
7: 1 Modbus-RTU protocol+ 1 Ethernet Modbus/TCP protocol	C: Double speed start	3:100A	3:AC 100V			X: Display module
	D: Resistor divider start	4:250A				
	E: Y/△ start	5:500A				
	H: Autotransformer start	6:800A				
	K: Protection mode					
	R: Start with soft-starter					
	P: Start with inverter					

Code	Adjustable Range	Configurable Motor Power (380V system)	Measurement Module	Diameter
1	0.2A~5A	0.13kW~2kW	WM1/05	φ18mm
2	5A~25A	2kW~11kW	WM1/25	φ18mm
3	25A~100A	11kW~55kW	WM1/100	φ18mm
4	100A~250A	45kW~115kW	WM1/250	Copper Bar
5	200A~500A	90kW~280kW (Configured with 3pcs of external CT 500A:5A)	WM1/05	φ18mm
6	500A~800A	280kW~400kW (Configured with 3pcs of external CT 800A:5A)	WM1/05	φ18mm



PRODUCT COMPONENTS

WDH-31-580 series Motor Protection Controller includes the following components:

Main control module (required)	Measurement Module (required, including connection line)	Switching module (optional)	Display module (optional, including connection line)

External CT (optional)-model: SHI-ZT40/SHI-ZT60, one set consisting of three pieces, protection type, specification: 500A/5A, 800A/5A. corresponding controller rated current of 5A



DIMENSIONS

Measurement Module
WM1: 5A, 25A, 100A (Perforation connection mode)

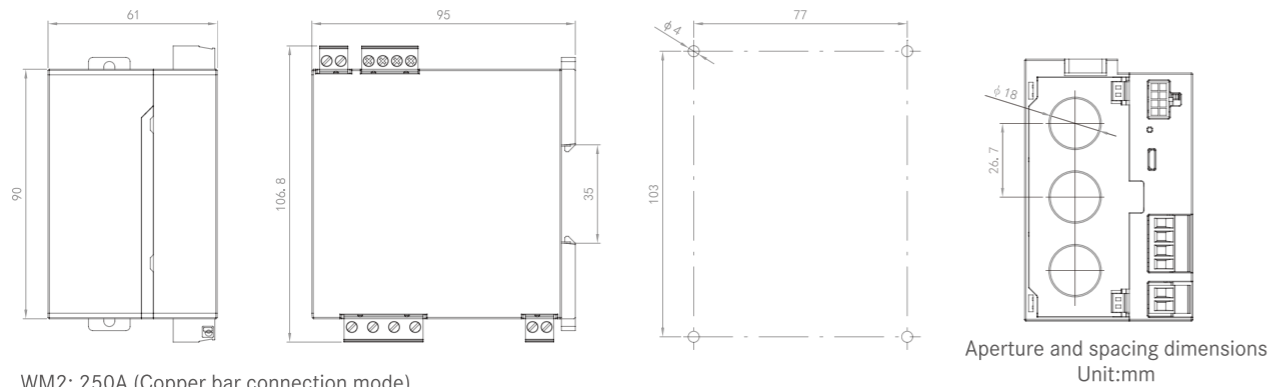

WM2: 250A (Copper bar connection mode)

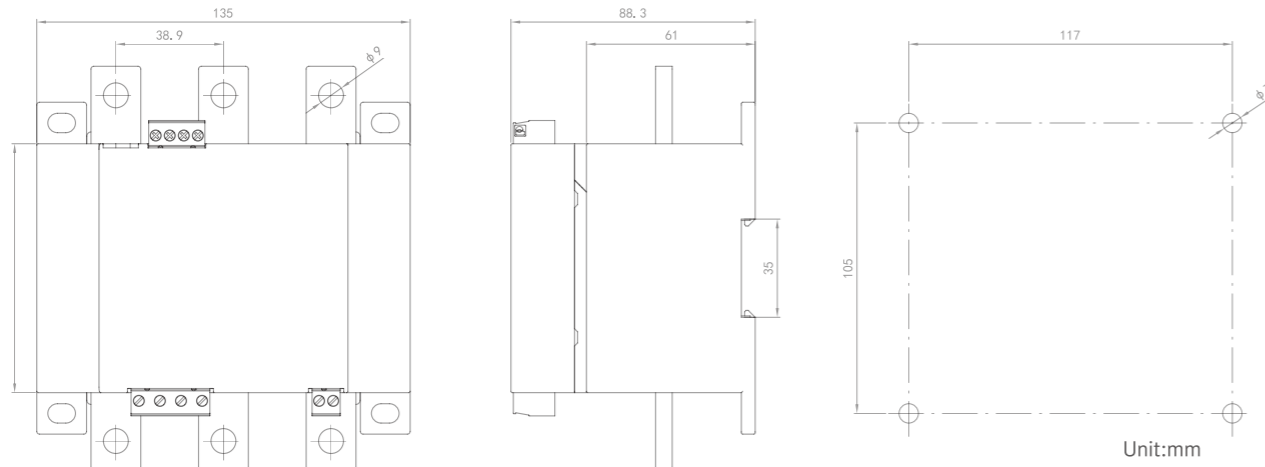

Main Control Module

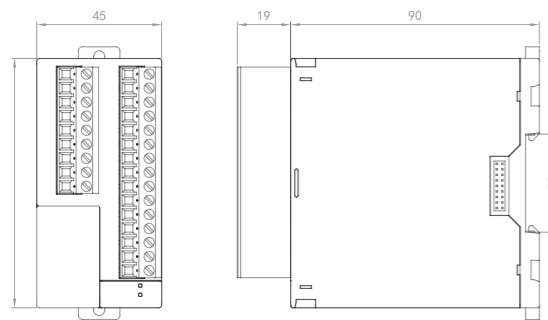

Switching Module

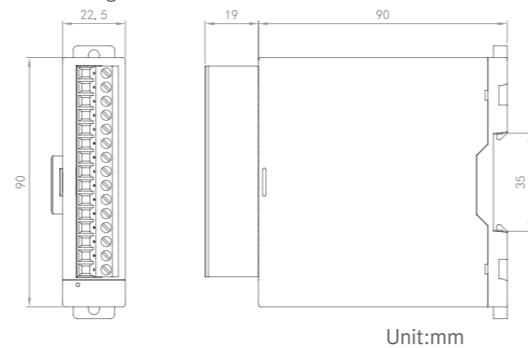

Display Module

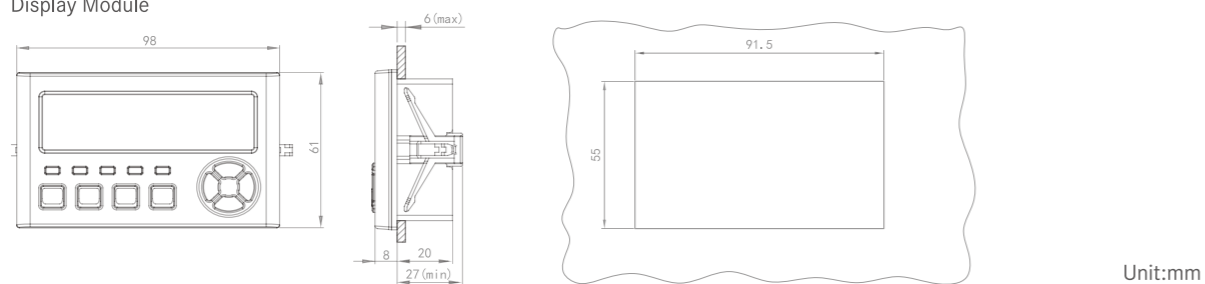

OPTIONAL CT

	External CT	
Model	SHI-ZT40	SHI-ZT60
Diameter(mm)	42×30	32×62.5
Dimension(mm)	75×44×102	100×50×112



TECHNICAL SPECIFICATION

System Running Parameter	Rated voltage of motor	AC380V,50HZ
	Rated current of motor	0.1~800A
	Insulation resistance	>100MΩ
Auxiliary Power Supply of Controller	Working Range	AC/DC 80~270V
Operating Environment	Environment temperature	-20°C~60°C
	Relative humidity	≤93%RH
	Storage temperature	-40°C~70°C
	Protection degree(front panel)	IP64
Attention	No corrosive gases, explosive and conductive media in the environment	
	Protection Accuracy	Current/ voltage starting value
Thermal capacity accumulated value	±1% of setting value	
	Delayed Action Time	Delayed action time<2S
Delayed action time≥2S		±5%
Relay Output	Control relay contact capacity	AC250V/5A
	Signal relay contact capacity	AC250V/3A,DC30V/3A
	Relay electric service time	100000 times
EMC Characteristics	Electrostatic discharge	Severity level: III
	Electrical fast transient burst	Severity level: III
	Surge	Severity level: III
	Oscillatory waves immunity	Severity level: III
	Electromagnetic field immunity	Severity level: III
	Radio frequency radiation immunity	Severity level: III
	Power frequency immunity	Severity level:A
	Conducted emission limit test	150kHz-30MHz
Radiation emission limits test	30MHz-1000MHz	
Withstand Voltage	Between power supply and input	AC2kV/1min
	Between power supply and output	AC2kV/1min
	Between input and output	AC1kV/1min



TYPICAL WIRING

Typical Wiring Diagram for Direct Start
(with input/output)

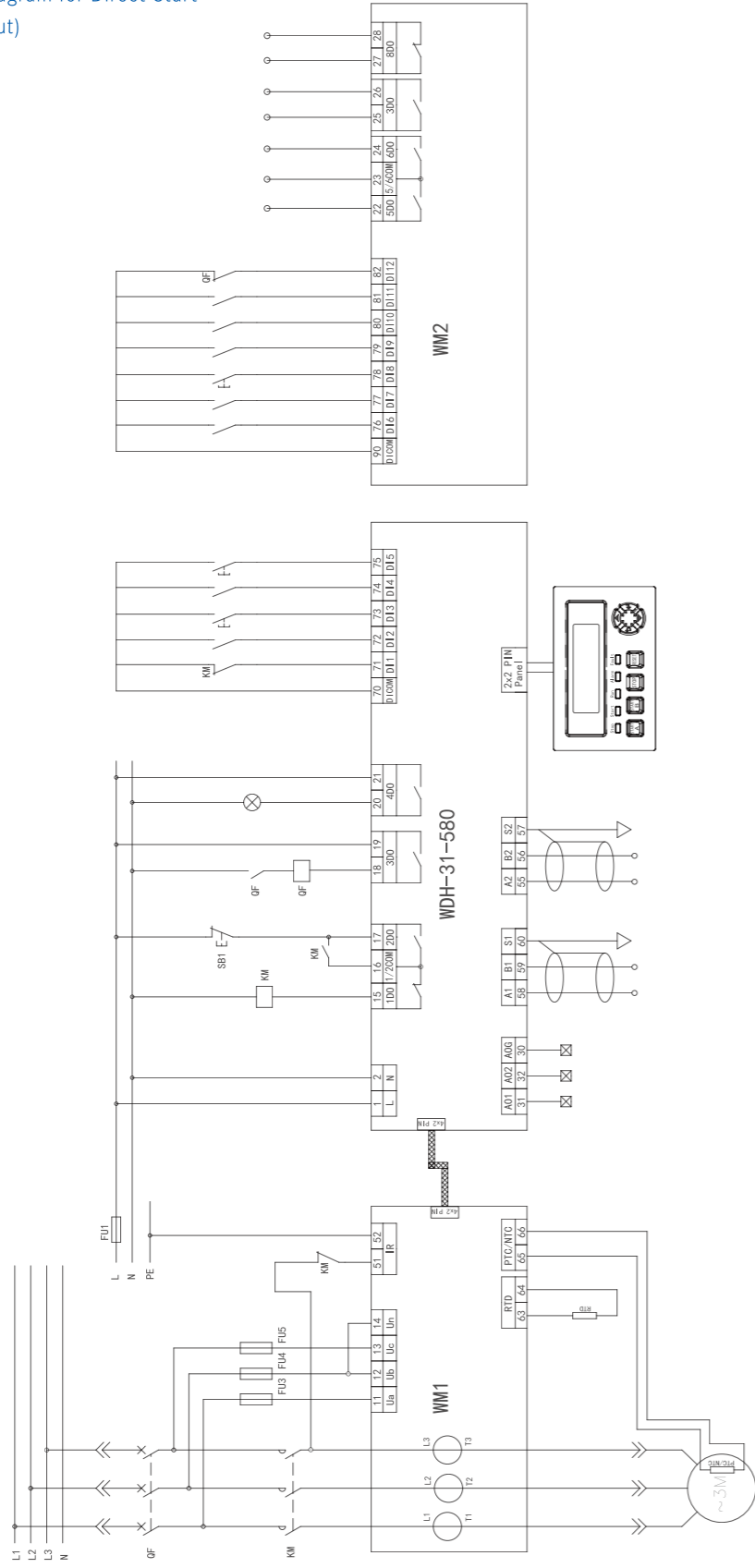

- Under the direct start mode, WDH-31-580 controls the motor start/stop by relay 1DO(NC)/2DO(NO).
- As drawing shown, when the controller receive the start command(such as 3DI terminal or display interface), 2DO closed(pulse), contactor(KM) power on, motor start
- When the controller receives the stop command(such as 5DI terminal or display interface), 1DO open(pulse), contactor KM power off, motor stop.
- When faults were detected, 1DO open(level), contactor KM power off, motor stop.
- After reset, 1DO closed, controller allows the motor restart again.

Typical Wiring Diagram for Bi-directional Start
(with input/ output)

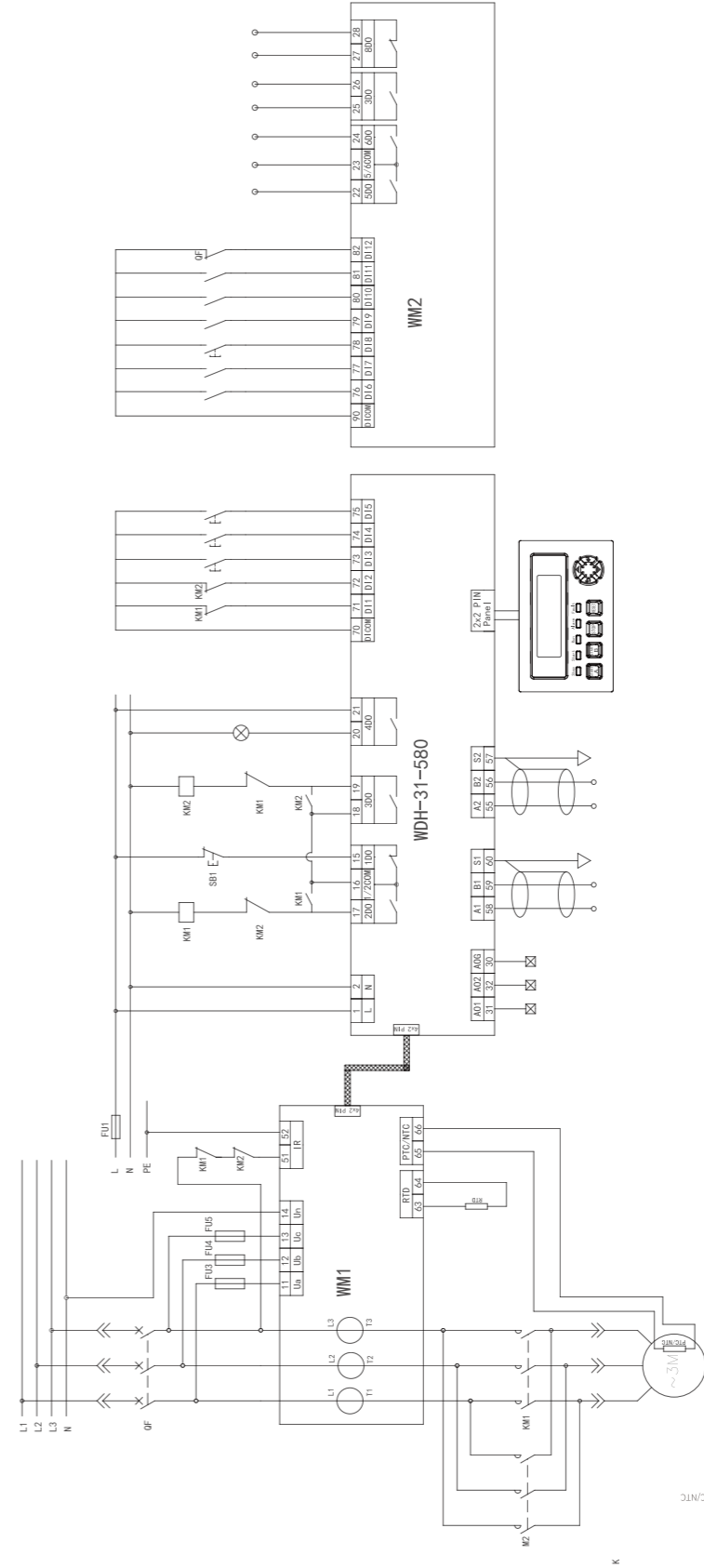

- In the bi-directional mode(forward/reverse rotation), WDH-31-580 controls the motor forward rotation start/stop by relay 1DO(NC)/2DO(NO), and by relay 1DO (NC)/3DO(NO) to the reverse direction start/stop of the motor.
- As the drawing shown, when the controller receives the forward directional start command(such as 3DI terminal or display interface), 2DO closed(pulse), contactor KM1 power on, the motor start with forward direction.
- When the controller receives the reverse direction start command (such as 4DI terminal or display interface), 3DO closed(pulse), contactor KM2 power on, the motor starts with reverse direction.
- When the controller receives the stop command (such as 5DI terminal or display interface), 1DO open (pulse), contactor KM1 /2 power off, the motor stop.
- If enable "Continuous Switching", if the current rotation direction is forward, the controller receives the reverse start signal, the motor will stop than delay 1s and start in reverse, or vice versa.